

USE AND MAINTENANCE MANUAL

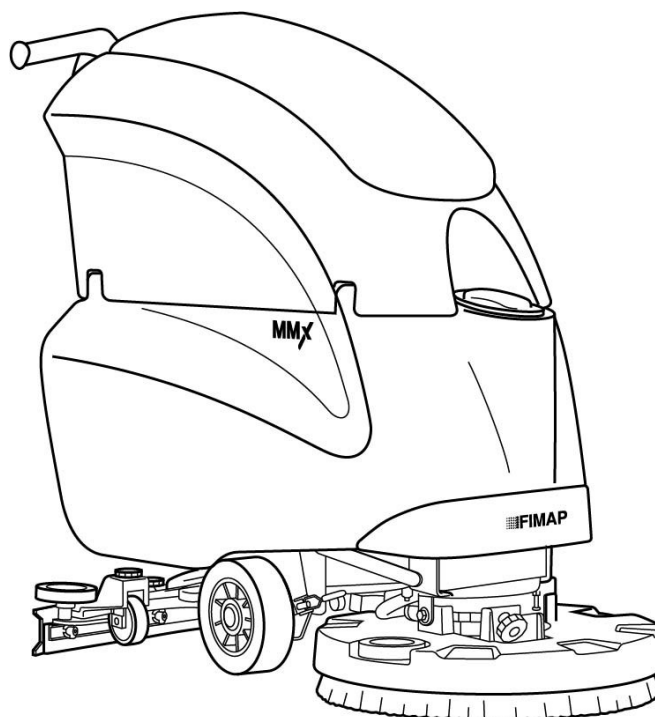

MMX B-BT 2014

ED. 09-2019

ENG

ORIGINAL
INSTRUCTIONS
Doc. 10016247
Ver. AF



CONTENTS

CONTENTS	2
SYMBOLS USED IN THE MANUAL	4
PURPOSE AND CONTENT OF THE MANUAL	5
TARGET GROUP	5
STORING THE USE AND MAINTENANCE MANUAL	5
ON DELIVERY OF THE APPLIANCE	5
INTRODUCTORY COMMENT	5
IDENTIFICATION DATA	5
TECHNICAL DESCRIPTION	5
INTENDED USE	5
SERIAL NUMBER PLATE	5
SAFETY	5
GENERAL SAFETY REGULATIONS	6
TECHNICAL DATA	7
TECHNICAL DATA	8
SYMBOLS USED ON THE APPLIANCE	9
PREPARING THE APPLIANCE	11
1. HANDLING THE PACKED APPLIANCE	11
2. HOW TO UNPACK THE MACHINE	11
3. HOW TO TRANSPORT THE APPLIANCE	11
4. COMPONENT POSITIONING.....	12
5. APPLIANCE SAFETY.....	12
6. BATTERY TYPE.....	13
7. BATTERY HOPPER MAINTENANCE AND DISPOSAL.....	13
8. INSERTING BATTERIES INTO THE DEVICE.....	13
9. BATTERY CHARGER CONNECTION (only for systems without CB).....	14
10. BATTERY CHARGER CONNECTION (only for systems with CB).....	15
11. HOUR METER.....	16
12. BATTERY CHARGE LEVEL INDICATOR.....	16
13. FORWARD MOVEMENT AT WORK SPEED (only for BT system).....	16
14. FILLING THE SOLUTION TANK.....	17
15. DETERGENT SOLUTION (only for versions without FSS).....	17
16. FILLING THE DETERGENT CANISTER (only for systems with FSS).....	17
17. ASSEMBLING THE SQUEEGEE	18
18. BRUSH ASSEMBLY (only for single-disc versions).....	19
19. BRUSH ASSEMBLY (only for twin-disc versions).....	19
20. ASSEMBLING THE SPLASH GUARD BRUSH HEAD	20
PREPARING TO WORK	21
1. PREPARING TO WORK.....	21
2. TRIGGERING THE DOSING SYSTEM (only for FSS system).....	21
WORK	23
1. STARTING WORK.....	23
2. DETERGENT ADJUSTMENT (only for versions without FSS).....	23
3. DETERGENT ADJUSTMENT (only for versions with FSS).....	23
4. "ECO MODE" DEVICE	24
5. OVERFLOW DEVICE.....	24
AT THE END OF THE WORK	25
DAILY MAINTENANCE	26
1. EMPTYING THE RECOVERY TANK.....	26
2. EMPTYING OF THE SOLUTION TANK.....	26
3. CLEANING THE SQUEEGEE BODY.....	26
4. CLEANING THE BRUSH.....	27
5. CLEANING THE SUCTION MOTOR FILTER FLOAT.....	28
6. CLEANING THE SOLUTION TANK FILTER.....	28
WEEKLY MAINTENANCE	29
1. CLEANING THE RECOVERY TANK	29
2. CLEANING THE SOLUTION TANK	29
3. CLEANING THE VACUUM HOSE.....	30
4. CLEANING THE DETERGENT CANISTER (only for system with FSS).....	30
EXTRAORDINARY MAINTENANCE	31
1. REPLACING THE SQUEEGEE RUBBERS	31
2. ADJUSTING THE SQUEEGEE.....	32
3. REPLACING THE BRUSH	32
4. REPLACING THE BRUSH HEAD SPLASH GUARD.....	33
5. RINSING THE DOSING SYSTEM (only for FSS system).....	33
TROUBLESHOOTING	35
1. AN ALARM MESSAGE APPEARS ON THE CONTROL DISPLAY	35
2. THE APPLIANCE DOESN'T SWITCH ON	35
3. THE BATTERIES ARE NOT CHARGED CORRECTLY	35

4.	THE DEVICE HAS A VERY LOW OPERATING AUTONOMY	35
5.	THE APPLIANCE DOES NOT MOVE	36
6.	INSUFFICIENT WATER ON THE BRUSHES.....	36
7.	THE DEVICE DOES NOT CLEAN CORRECTLY	36
8.	THE SQUEEGEE DOES NOT DRY PERFECTLY.....	36
9.	EXCESSIVE FOAM PRODUCTION (RECOVERY TANK).....	37
10.	THE VACUUM MOTOR DOES NOT FUNCTION	37
11.	BYPASSING THE WATER SYSTEM SUPPLY PUMP (only for FSS versions).....	37
	DISPOSAL	38
	CHOOSING AND USING BRUSHES	39
	EC DECLARATION OF CONFORMITY	40

The descriptions contained in this document are not binding. The company therefore reserves the right to make any modifications at any time to elements, details, or accessory supply, as considered necessary for reasons of improvement or manufacturing/commercial requirements. The reproduction, even partial, of the text and drawings contained in this document is prohibited by law.

The company reserves the right to make any technical and/or supply modifications. The images are for reference purposes only, and are not binding in terms of design and supply.

SYMBOLS USED IN THE MANUAL



Open book symbol with an "i"
Indicates the need to consult the instruction manual.



Open book symbol
Tells the operator to read the user manual before using the device.



Warning symbol.
Carefully read the sections preceded by this symbol meticulously following the instructions indicated for the safety of the operator and the device.



Danger symbol.
Indicates the presence of substances and compounds which could harm any living tissue they come into contact with.



Warning symbol.
Presence of gaseous substances with a low flash point.



Disposal symbol.
Carefully read the sections marked with this symbol for the disposal of the machine.



Warning symbol.
Indicates that the packed product should be handled with suitable carriages that conform to legal requirements.



Covered place symbol.
The operations preceded by this symbol must be rigorously carried out in a dry, indoor area.



Recycling symbol.
Carefully read the sections marked with this symbol for the recycling of the machine.

PURPOSE AND CONTENT OF THE MANUAL

The aim of this manual is to provide customers with all the information needed to use the appliance in the safest, most appropriate and most autonomous way. It gives information concerning technical aspects, safety, operation, downtime, maintenance, spare parts and scrapping. Operators and qualified technicians must read the instructions in this manual carefully before carrying out any operation on the appliance. If in doubt about the correct interpretation of instructions, contact your nearest Customer Service Centre to obtain the necessary clarifications.

TARGET GROUP

This manual is aimed at both the operator and qualified technicians responsible for machine maintenance. Operators must not perform operations that should be carried out by qualified technicians. FIMAP SpA cannot be held liable for damages resulting from failure to comply with this prohibition.

STORING THE USE AND MAINTENANCE MANUAL

The Use and Maintenance Manual must be stored in its special pouch close to the appliance, protected from liquids and anything else that could compromise its legibility.

ON DELIVERY OF THE APPLIANCE

When the machine is delivered to the customer, an immediate check must be performed to ensure all the material mentioned in the shipping documents has been received, in addition to verifying that the equipment has not been damaged during transportation. If this is the case, the carrier must ascertain the extent of the damage at once, informing our customer service office. It is only by prompt action of this type that the missing material can be obtained, and compensation for damage successfully claimed.

INTRODUCTORY COMMENT

Any type of equipment can only work properly and effectively if used correctly and kept in full working order by performing the maintenance operations described in the attached documentation. You should therefore read this instruction manual carefully, consulting it again if issues arise while using the machine. If necessary, remember that our assistance service (organised in collaboration with our dealers) is always available for advice or direct intervention.

IDENTIFICATION DATA

For technical assistance or to request replacement parts, always give the model, the version and the serial number (written on the relevant plate).

TECHNICAL DESCRIPTION

MMx is a scrubbing machine that is able to clean a wide range of flooring and dirt types by means of the mechanical action of one or two cylindrical brushes and the chemical action of a water-detergent solution. As it advances, it also collects the dirt removed and the detergent solution not absorbed by the floor. **The appliance must only be used for this purpose.**

INTENDED USE

This scrubbing machine was designed and built for the cleaning (scrubbing and drying) of smooth, compact flooring in the commercial, residential and industrial sectors by a qualified operator in proven safety conditions. The scrubbing machine is not suitable for cleaning rugs or carpets. The appliance is only suitable for use in indoor - or at least covered - areas. The appliance is not suitable for use in the rain, or under jets of water. **IT IS FORBIDDEN** to use the appliance for picking up dangerous dusts or inflammable liquids in places with an explosive atmosphere. In addition, it is not suitable as a means of transport for people or objects.



SERIAL NUMBER PLATE

The serial number plate is located in the battery compartment and, more precisely, in the lower section of the tank. It indicates the machine's general

characteristics and, specifically, its serial number. The serial number is a very important piece of information and should always be provided together with any request for assistance or when purchasing spare parts.

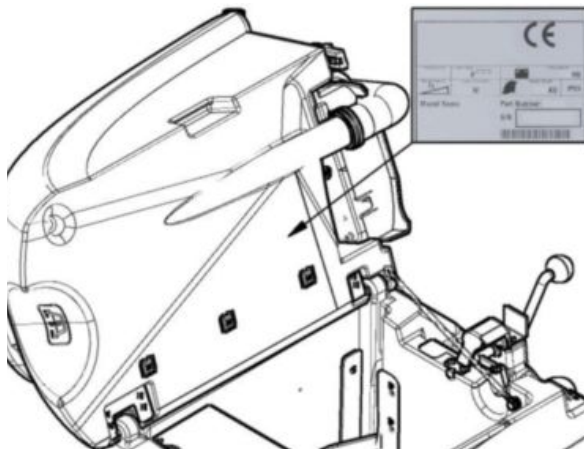

SAFETY

Operator cooperation is paramount for accident prevention. No accident prevention programme can be effective without the full co-operation of the operator who is directly responsible for machine operation. The majority of occupational accidents that happen both in the workplace or whilst moving are caused by failure to respect the most basic safety rules. An attentive, careful operator is most effective guarantee against accidents and is fundamental in order to implement any prevention programme.

GENERAL SAFETY REGULATIONS

Before using the machine, please read the following document carefully and follow the instructions contained herein, along with the instructions in the document supplied with the machine itself. "GENERAL SAFETY

TECHNICAL DATA	UM	MMx 43 B	MMx 43 BT	MMx 50 B	MMx 50 BT
Nominal input power [IEC 60335-2-72; IEC 62885-9]	kW	0,91	1,06	0,91	1,06
Working width	mm	430	430	510	510
Squeegee width (standard – optional)	mm	700-800	700-800	700-800	700-800
Working capacity	m ² /h	1590	1790	1925	2125
Brush diameter	No. / ∅ mm	1 / 430	1 / 430	1 / 510	1 / 510
Brush rpm	rpm	140	140	140	140
Force exerted on brush	N	205	205	205	205
Brush motor	V/W	24/500	24/500	24/500	24/500
Forward speed type		Semi-aut.	Automatic	Semi-aut.	Automatic
Traction motor	V/W	-	24/150	-	24/150
Maximum gradient		2%	10%	2%	10%
Forward speed	Km/h	-	4	-	4
Suction motor	V/W	24/410	24/410	24/410	24/410
Maximum vacuum [IEC 62885-9; IEC 60312-1]	kPa	10,6	10,6	10,6	10,6
Solution tank	l	40	40	40	40
Recovery tank	l	50	50	50	50
Detergent canister (versions with FSS)	l	3	3	3	3
Battery compartment dimensions (Length / Height / Width)	mm	355 x 235 x 335	355 x 235 x 335	355 x 235 x 335	355 x 235 x 335
Machine dimensions (Length / Height / Width)	mm	1090x1010x590	1090x1010x590	1170x1010x590	1170x1010x590
Recommended battery (12 MFP 80)	V / AhC ₅	12 / 80	12 / 80	12 / 80	12 / 80
Recommended battery weight	kg	27	27	27	27
Appliance weight	kg	75	95	75	95
Appliance weight during transport	kg	129	149	129	149
Appliance weight when ready to use	kg	169	189	169	189
Sound pressure level in operator seat [ISO 11201] (L _{pA})	dB	62	62	62	62
Uncertainty K _{pA}	dB	1.5	1.5	1.5	1.5
Hand-arm vibrations [IEC 60335-2-72; IEC 62885-9; ISO 5349-1]	m/s ²	0.75	0.75	0.75	0.75
Uncertainty		3,5%	3,5%	3,5%	3,5%

TECHNICAL DATA	UM	MMx 52 B	MMx 52 BT
Nominal input power [IEC 60335-2-72; IEC 62885-9]	kW	0,81	0.96
Working width	mm	500	500
Squeegee width (standard – optional)	mm	700-800	700-800
Working capacity	m ² /h	1850	2050
Brush diameter	No. / ∅ mm	2 / 255	2 / 255
Brush rpm	rpm	275	275
Force exerted on brush	N	205	205
Brush motor	V/W	24/400	24/400
Forward speed type		Semi-aut.	Automatic
Traction motor	V/W	-	24/150
Maximum gradient		2%	10%
Forward speed	Km/h	-	4
Suction motor	V/W	24/410	24/410
Maximum vacuum [IEC 62885-9; IEC 60312-1]	kPa	10,6	10,6
Solution tank	l	40	40
Recovery tank	l	50	50
Detergent canister (versions with FSS)	l	3	3
Built-in battery charger	V/A	24/9	24/9
Battery compartment dimensions (Length / Height / Width)	mm / mm / mm	355 x 235 x 335	355 x 235 x 335
Machine dimensions (Length / Height / Width)	mm / mm / mm	1105x1010x590	1105x1010x590
Recommended battery (12 MFP 80)	V / AhC ₅	12 / 80	12 / 80
Recommended battery weight	kg	27	27
Appliance weight	kg	81	101
Appliance weight during transport	kg	135	155
Appliance weight when ready to use	kg	175	195
Sound pressure level in operator seat [ISO 11201] (LpA)	dB	62	62
Uncertainty K _{pA}	dB	1.5	1.5
Hand-arm vibrations [IEC 60335-2-72; IEC 62885-9; ISO 5349-1]	m/s ²	0.75	0.75
Uncertainty		3,5%	3,5%

SYMBOLS USED ON THE APPLIANCE

I

O

Main switch or key switch symbol

It is used on the instrument panel to indicate the green or red warning light showing that the main key switch is either on (I) or off (O).



Symbol used in the solution tank to indicate the maximum temperature of the water used to fill the solution tank.



Tap position symbol.

Used on the rear of the solution canister to indicate the position of the detergent solution tap.

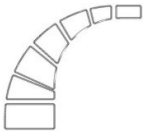

Water quantity regulation symbol.

Used on the rear of the solution tank to indicate the knob for adjusting the quantity of water supplied to the device's water system.



Indicates the risk of crushed hands.

X %

Symbol used on the serial number plate to indicate the maximum gradeability.



Label with instructions for the use of standard or concentrated detergents (FSS system only).



Label with warnings on the type of detergent to use (FSS system only).



Label with Ph value of the detergent to use (FSS system only).



Label with forward speed symbol (only for BT versions).

Used on the instrument panel to indicate the position of the potentiometer that controls the appliance's movement speed.



Detergent percentage adjustment symbol (FSS system only).

Used on the control panel to indicate the knob for regulating the percentage of detergent present in the machine's water circuit.

SYMBOLS USED ON THE APPLIANCE

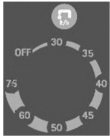

Symbol for water amount adjustment (FSS system only).
Used on the control panel to indicate the knob for adjusting the water level in the machine's water circuit.



Brush uncoupling symbol (only for single-disc versions).
Used on the control panel to indicate the button for uncoupling the brush.

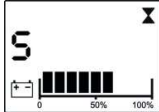

Symbol for active brush uncoupling system (only for single-disc versions).
Used on the control display to indicate that the brush is being uncoupled.



ECO-MODE symbol.
Used on the control panel to indicate the button that activates the appliance's ECO mode.

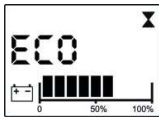

Symbol for active "ECO-MODE" working program.
Used on the control display to indicate that the "ECO-MODE" work programme is active, which translates into a reduction in energy consumption and detergent solution.

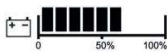

Battery charge level symbol.
Used on the control display to indicate the state of charge of the batteries.

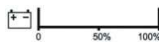

Critical battery charge level symbol.
Used on the control display to indicate the critical state of charge of the batteries and the need to recharge them.

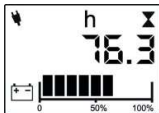

Symbol of battery charging underway (only for battery charger versions).
Used on the control display to indicate the state of charge of the batteries.



Label with general warnings on appliance use.
The label shows warnings to be complied with for the proper operation of the appliance.



Label with general warnings on appliance use (only for battery charger versions).
The label shows warnings to be complied with for the proper operation of the appliance.



Symbol for FSS system tap control lever (only for MMx50 versions with FSS system).
Used on the brush head base to indicate how to position the tap lever in order to bypass the automatic dosing system.

PREPARING THE APPLIANCE

1. HANDLING THE PACKED APPLIANCE

The device is delivered in dedicated packaging. The packaging elements (plastic bags, clips, etc.) are potentially hazardous, and, therefore, must not be left within the reach of children, incapacitated persons, etc. The device is housed in dedicated packaging fitted with a pallet to facilitate fork-lift handling. The packages CANNOT be placed on top of each other.

Gross weight of device, including packaging, is:
 MMx 43-50-52 B: 100 kg (weight of unladen device including packaging)
 MMx 43-50-52 BT: 120 kg (weight of unladen device including packaging)

The dimensions of the package are as follows:

MMx
 A : 665 mm
 B : 1230 mm
 C : 1145 mm

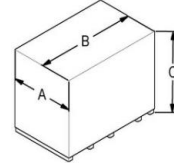

ATTENTION: It is recommended that all the packaging components be kept in case the appliance ever needs transporting.



ATTENTION: Move the packaged product with handling equipment that complies with legal requirements regarding size and mass of the packaging.

2. HOW TO UNPACK THE MACHINE

The procedure for removing the device from its packaging is the following:

1. Remove the outer package.
2. Check that the main switch (1) is in the "0" position. If this is not the case, turn the key by a quarter of a turn to the left.
3. Remove the key from the instrument panel.
4. The device is secured to the pallet with wedges (2) that lock the wheels. Remove the wedges.



ATTENTION: During this operation, check there are no people or objects near the device.

ATTENTION: users are advised to always wear protective gloves, to avoid the risk of serious injury to hands.

5. For BT versions, take off the parking break by rotating the lever (3) in the sense shown by the picture.
6. Using a chute, bring the machine down from the pallet. Do not assemble the brushes and the rear squeegee before unloading the device, and avoid violently jolting the brush head unit and the squeegee support.
7. Keep the pallet and all packaging components for any future transport needs.

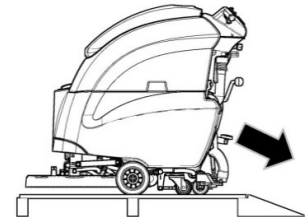
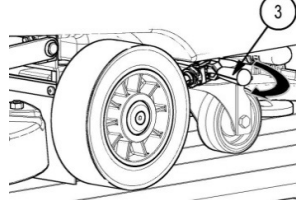
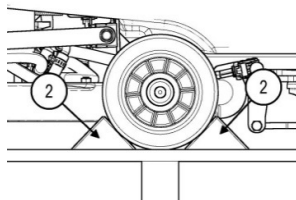

3. HOW TO TRANSPORT THE APPLIANCE

The procedure for the safe handling of the device is the following:

1. Using a chute, slide the machine onto the pallet.
2. Do what is required to make sure the appliance is in a safe condition (see "[APPLIANCE SAFETY](#)").
3. Grip the handle (1) on the rear left side of the recovery tank and turn the recovery tank until it reaches the work position.
4. Secure the recovery tank with the hinge (2).
5. Carry out this operation with the rear squeegee and the brushes detached from the machine.
6. Secure the device to the pallet using wedges (3).

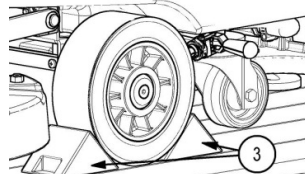
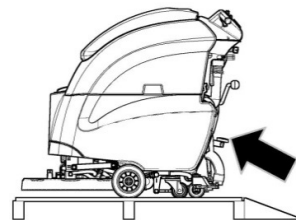
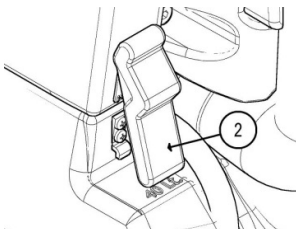
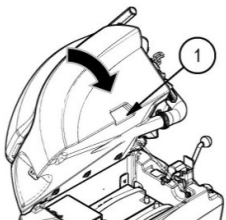

PREPARING THE APPLIANCE

4. COMPONENT POSITIONING

The control panel components are identified as follows:

1. Levers to activate brushes/traction (located beneath the grip)
2. Water outlet adjustment switch (Versions with FSS)
3. Detergent outlet adjustment switch (Versions with FSS)
4. Main switch
5. Command display
6. Speed adjustment knob (BT versions)
7. Brush uncoupling/eco-mode button
8. Brush head unit lifting button
9. Water/solution level tube
10. Recovery tank drainage tube
11. Hinge to close the tanks
12. Compartment for battery charger / storage (depending on the model)
13. Squeegee lifting lever
14. Solution filter
15. Water outlet manual adjustment tap
16. Recovery tank rotation handle
17. Parking brake lever (only for BT versions)
18. Vacuum system assembly rotation handle
19. Upper storage compartment
20. Solution tank inlet

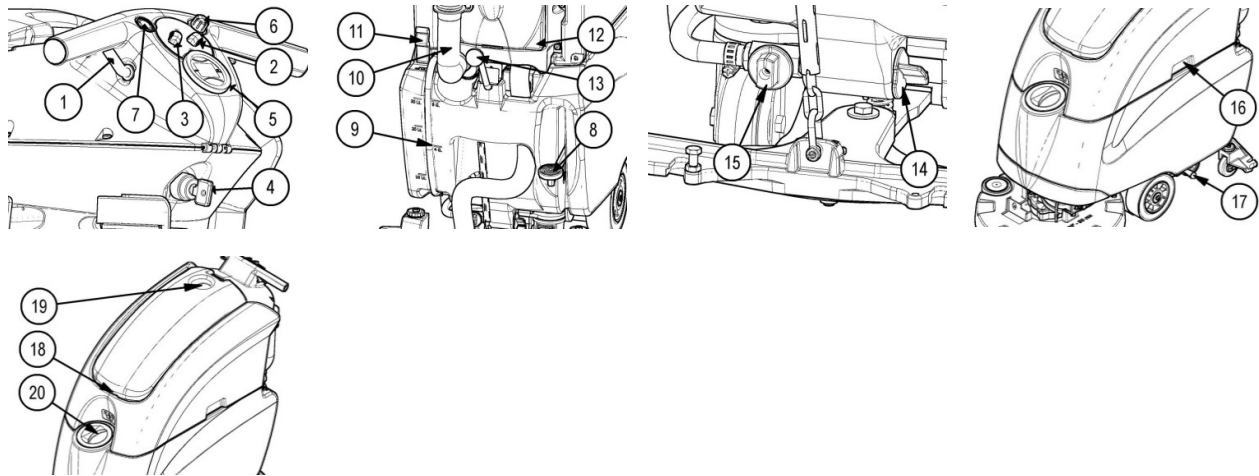

5. APPLIANCE SAFETY

The stages for making the appliance safe, thereby making it possible to carry out operations safely, are as follows:

1. Check that the solution tank and recovery tank are empty; empty them if not (see the paragraph, [“EMPTYING THE RECOVERY TANK”](#) or [“EMPTYING THE SOLUTION TANK”](#)).



ATTENTION: The tanks should be emptied in the place used for draining dirty water.

ATTENTION: The place given over to this operation must comply with current environmental protection regulations.

2. Check that the main switch is in the “0” position; if this is not the case, turn the key (1) by a quarter of a turn to the left. Remove the key from the instrument panel.
3. Check that the brush head unit is raised from the floor; if necessary turn the pedal (2) at the bottom of the device anticlockwise.
4. Check that the squeegee body is raised from the floor; if necessary use the lever (3) at the rear of the device.

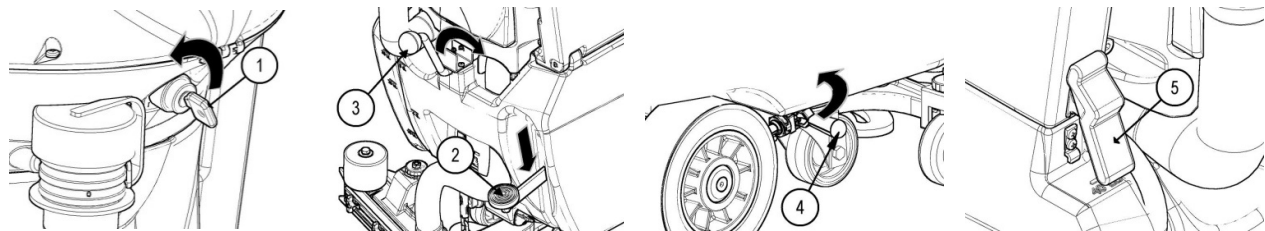

5. For BT versions, check that the parking brake is on. If this is not the case, rotate the lever (4) in the sense shown by the picture
6. Remove the recovery tank using the hinge (5).
7. Grip the handle (6) on the left-hand side of the recovery tank.
8. Lift the recovery tank until you reach the end position.
9. Disconnect the battery connector (7) from the connector of the general system (8).

PREPARING THE APPLIANCE

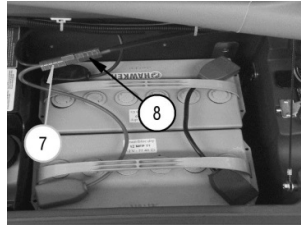
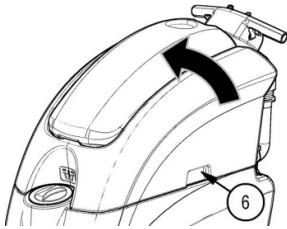

6. BATTERY TYPE

To power the device you can use:

- lead tubular plate traction batteries with liquid electrolyte.
- airtight traction batteries with gas-recombination gel technology or AGM.

OTHER TYPES CANNOT NOT BE USED.

Every battery consists of DIN-type elements connected in series and supplying 12V power to the clamps. The battery compartment can house two 12V batteries. For a good working performance, we suggest using 12 V sealed gel batteries.

7. BATTERY HOPPER MAINTENANCE AND DISPOSAL

For maintenance and recharging, respect the instructions provided by the battery manufacturer.

Special attention must be paid to the choice of battery charger, which differs according to the battery type and capacity.

When the battery elements in the battery hopper are exhausted, the battery hopper needs to be disconnected by specialised and trained staff, and lifted and removed from the battery compartment using suitable lifting devices. **BATTERY HOPPER BATTERY ELEMENTS ARE CLASSIFIED AS DANGEROUS WASTE AND MUST BE CONSIGNED TO THE AUTHORISED BODIES FOR CORRECT DISPOSAL.**

8. INSERTING BATTERIES INTO THE DEVICE

The batteries must be housed in the special compartment beneath the recovery tank and should be handled using lifting equipment that is suitable in terms of both weight and coupling system. The batteries must also comply with the requirements of the CEI 21-5 Standard. The dimensions of the battery compartment are: 355 x 337 x H=220 mm.

ATTENTION: for battery maintenance and daily recharging, you must fully respect the indications provided by the manufacturer or retailer. All installation and maintenance operations must be carried out by specialised personnel.



ATTENTION: Before handling the batteries, ensure that you comply with accident prevention regulations applicable in the country where you work or with DIN EN 50272-3 and DIN EN 50110-1 Standards.

ATTENTION: to prevent an accidental short circuit use insulated tools to connect the batteries, and do not place or drop metal objects on the battery. Remove rings, watches and any clothing with metal parts that may come into contact with the battery terminals.

To insert the batteries into the compartment, proceed as follows:

1. Take all necessary steps to ensure that the device is in a safe condition (see "[MACHINE SAFETY](#)").

ATTENTION: Before installing the battery hopper, clean the battery compartment with a damp cloth. Check that the connectors on the cables supplied are functioning correctly.



ATTENTION: Check that the characteristics of the battery hopper that you are looking to use are appropriate for the type of work to be performed. Verify the charge state of each element of the battery hopper and the state of the contacts present on each of its elements.

ATTENTION: users are advised to always wear protective gloves, to avoid the risk of serious injury to hands.

ATTENTION: Before inserting the batteries, lift the bottom and connect the traction connector (this step is only to be performed for BT versions of the device). This process must be carried out by qualified personnel. An incorrect connection of the connector may cause a malfunction of the device.

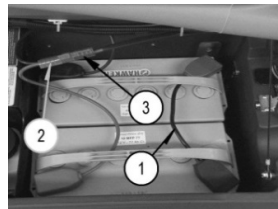

PREPARING THE APPLIANCE

2. House the batteries in the compartment, positioning the poles "+" and "-" opposite each other
3. Connect to the battery drop cable (1) to the "+" and "-" terminals, so as to create a 24V voltage at the terminals.
4. Connect the battery connector (2) to the general system connector (3).



ATTENTION: It is recommended that all installation and maintenance operations should be carried out by expert personnel, trained by the dedicated technical service centre.

ATTENTION: users are advised to always wear protective gloves, to avoid the risk of serious injury to hands.

5. Grip the handle on the recovery tank and turn it until it reaches the work position.

9. BATTERY CHARGER CONNECTION (only for systems without CB)

In order not to cause permanent damage to individual battery elements, it is essential to avoid their complete discharge by recharging them within a few minutes from the "discharged battery" warning light being switched on.



ATTENTION: Never leave individual battery elements completely discharged, even if the machine is not in operation. Check the battery charger is suitable for the batteries installed, in terms of both capacity and type.

To connect the battery charger you must:

1. Move the appliance to the designated battery charging area.



ATTENTION: Park the device in an area protected from the elements and with suitable ventilation, on a flat and level surface. There must be no objects near the device that could either damage it, or be damaged through contact with it.

2. Take all necessary steps to ensure that the device is in a safe condition (see "[MACHINE SAFETY](#)").

ATTENTION: This process must be carried out by qualified personnel. An incorrect connection of the connector may cause a malfunction of the device.



ATTENTION: Check that the battery charger used is suitable for the batteries in the device and set up for the batteries installed.

ATTENTION: carefully read the use and maintenance instructions of the battery charger that is used for charging.

3. Connect the battery charger cable connector to the battery connector (2).
4. Connect the recently wired cable to the external battery charger.



ATTENTION: keep the recovery tank open for the duration of the battery recharging cycle to allow gas fumes to escape.

ATTENTION: the room used to recharge the batteries must be adequately ventilated to prevent the accumulation of gases that leak from batteries.

The coupling connector of the battery charger is supplied inside the bag containing this instruction booklet, and must be fitted to the battery charger cables as shown in the instructions.



ATTENTION: Danger of gas exhalation and leakage of corrosive liquids.



ATTENTION: Danger of fire: keep naked flames at a safe distance

5. When the recharge cycle is complete, disconnect the battery charger supply cable from the battery charger.
6. Disconnect the battery charger connector from the battery connector (2).
7. Connect the battery connector (2) to the connector of the general system (3).
8. Grip the handle on the recovery tank and turn until it reaches the work position.

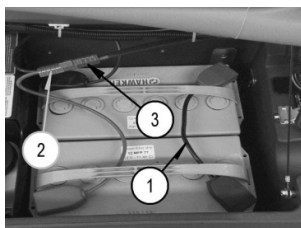

PREPARING THE APPLIANCE

10. BATTERY CHARGER CONNECTION (only for systems with CB)

In order not to cause permanent damage to individual battery elements, it is essential to avoid their complete discharge by recharging them within a few minutes from the "discharged battery" warning light being switched on.



ATTENTION: Never leave individual battery elements completely discharged, even if the appliance is not in operation. Check the battery charger is suitable for the batteries installed, in terms of both capacity and type.

To connect the battery charger you must:

1. Move the appliance to the designated battery charging area.



ATTENTION: Park the device in an area protected from the elements and with suitable ventilation, on a flat and level surface. There must be no objects near the device that could either damage it, or be damaged through contact with it.

2. Check that the recovery tank is empty; if not, empty it using the tube provided for this purpose (1) positioned at the rear of the device (read the section "[EMPTYING THE RECOVERY TANK](#)").
3. Check that the main switch is in the "0" (2) position. If this is not the case, turn the key by a quarter of a turn to the left. Remove the key from the instrument panel.
4. Check that the brush head unit is raised from the floor, if necessary turn the pedal (3) at the bottom of the device anticlockwise.
5. Check that the squeegee unit is raised from the floor; if necessary use the lever (4) at the rear of the device.
6. For BT versions, check that the parking brake is on. If this is not the case, rotate the lever (5) in the sense shown by the picture.
7. Remove the recovery tank using the hinge (6).
8. Grip the handle (7) on the rear left side of the recovery tank and turn the recovery tank until it reaches the end position.
9. Open the drawer by pressing on the handle (8) located on the rear of the appliance.
10. Connect the battery charger cable to the socket on the charger itself.
11. Plug the battery charger cable into the mains socket.



ATTENTION: keep the recovery tank open for the duration of the battery recharging cycle to allow gas fumes to escape.

ATTENTION: the room used to recharge the batteries must be adequately ventilated to prevent the accumulation of gases that leak from batteries.

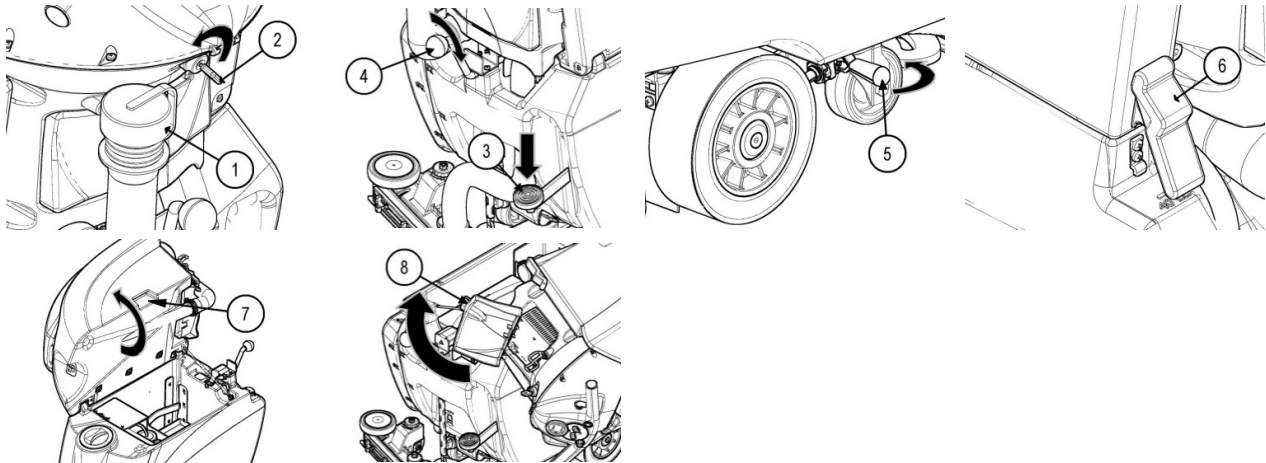

ATTENTION: Carefully read the use and maintenance manual of the charger that is delivered inside the bag containing this instruction booklet.



ATTENTION: Before inserting the battery charger power cable into the socket, verify that there is no condensate or other forms of liquids.

ATTENTION: If the device's electrical system is inadvertently powered, the "POWER PLUG" symbol will be displayed on the top left side of the control display. No controls will be operational whilst the battery is being charged.

PREPARING THE APPLIANCE

12. When the recharge cycle is complete, disconnect the battery charger power supply cable from wall plug.
13. Disconnect the battery charger cable from the charger socket.
14. Close the drawer.

11. HOUR METER

The control display is on the rear of the appliance. The second screen that appears after it is switched on shows the appliance's total usage time. The digits that precede the "." symbol identify hours, whilst the digit that follows it indicates hour decimals (an hour decimal corresponds to six minutes). When the "hour glass" symbol (1) is flashing it indicates that the hour meter is counting the appliance's operating time.

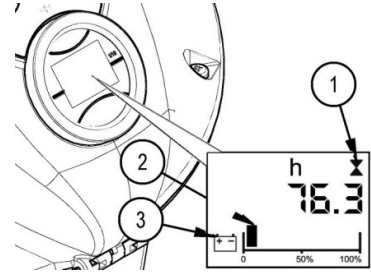

12. BATTERY CHARGE LEVEL INDICATOR

The control display is on the rear of the appliance. The graphic symbol that identifies the charge level of batteries appears at the bottom of the command display. The indicator consists of charge level indicators. With the minimum remaining charge is reached, the graphic symbol (2) will start to blink and will switch off after a few seconds and then the symbol (3) will start to blink. Under these conditions, take the device to the battery charge area.

ATTENTION: A few seconds after the battery charge level reaches the critical level (1), the brush motor switches off automatically. With the remaining charge it is possible to complete the drying process before starting the recharge.

ATTENTION: A few seconds after the battery charge level reaches the discharge level (2), the suction motor switches off automatically. With the remaining charge, however, it is still possible to take the appliance to its dedicated recharging area (BT versions).



13. FORWARD MOVEMENT AT WORK SPEED (only for BT system)

This appliance is equipped with electronic traction control. To move the appliance, follow the steps detailed below:

1. Check that the potentiometer adjustment knob (1) is set to minimum; if this is the case, fully turn it anti-clockwise.
2. Turn the main machine switch (2) to "I"; turn the key by a quarter turn to the right.
3. Engage the dead man's levers (3) on the handlebars.
4. Adjust the desired forward speed by turning the knob (1) gradually to the right.

ATTENTION: The device will not start to move (either forward or backward) if the potentiometer adjustment knob (1) is set to minimum.



ATTENTION: Forward speed can be increased by turning the potentiometer's knob (1) clockwise.

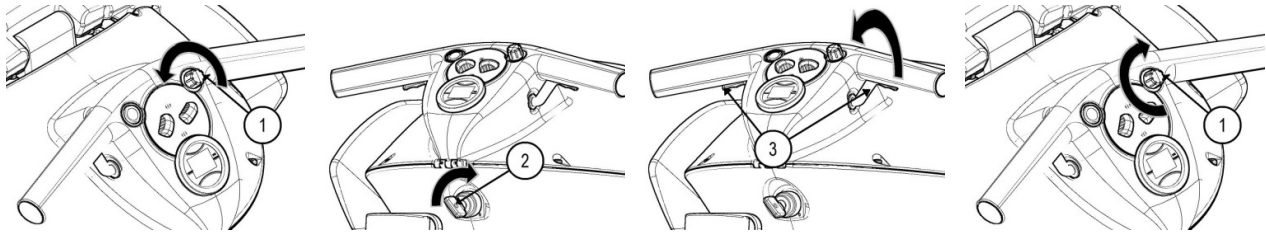

To reverse, proceed as follows:

1. Check that the brush head unit is raised from the floor; if necessary turn the pedal (4) at the bottom of the device anticlockwise.
2. Check that the squeegee unit is raised from the floor; if necessary action the lever (5) at the rear of the device.
3. Engage the dead man's levers (3) on the handlebars in order to start the appliance's movement.

WARNING: the reverse speed is lower than the forward speed to comply with current health and safety standards. If the potentiometer is adjusted while reversing, the adjustment of the forward speed will be automatically changed.



WARNING: It is impossible to reverse if the squeegee body touches the floor. In order to reverse, lift the squeegee body from the floor using the relevant lever on the back of the appliance.

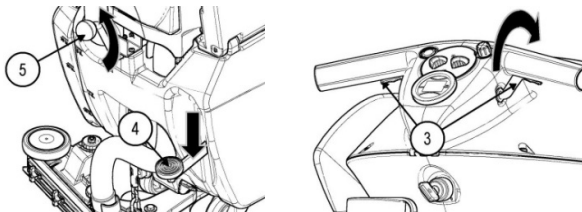

PREPARING THE APPLIANCE

14. FILLING THE SOLUTION TANK

Before filling the solution tank, carry out the following steps:

1. Take the machine to the dedicated solution tank filling area.
2. Do what is required to make sure the appliance is in a safe condition (see "[APPLIANCE SAFETY](#)").
3. Grip the handle (1) on the rear left side of the recovery tank and turn the recovery tank until it reaches the work position.
4. Secure the recovery tank with the hinge (2).
5. Check that the solution tank discharge plug (3) has been tightened, if that is not the case, not turn it clockwise.
6. Unscrew the filler cap (4) and fill the solution tank using a rubber hose or bucket.



ATTENTION: Check that the filter (5) under the filler cap (4) is positioned correctly; this is to prevent impurities and dirt causing malfunctions to the appliance's water system.

7. Fill with clean water, at a temperature not higher than 50°C and not lower than 10°C. The tank level can be checked using the level indicator (6) on the left-hand side at the rear of the appliance.

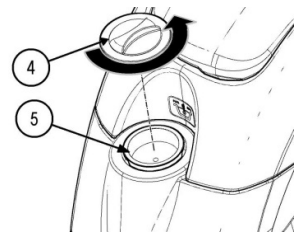
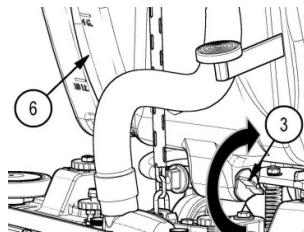
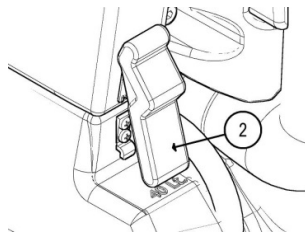
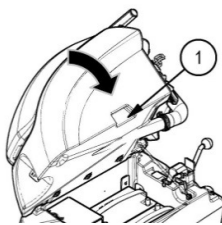

15. DETERGENT SOLUTION (only for versions without FSS)

After filling the solution tank with clean water add the liquid detergent to the tank in the concentration and manner indicated on the detergent manufacturer's label. To prevent the formation of an excessive amount of foam that could damage the vacuum motor, use the minimum percentage of detergent required.

ATTENTION: Always use detergents whose manufacturer's label indicates their suitability for scrubbing machines. Do not use acid or alkaline products or solvents without this indication.



ATTENTION: acid or alkaline maintenance detergents can be used, as long as they have pH values between 4 and 10, and do not contain: oxidising agents, chlorine or bromine, formaldehyde, mineral solvents.

ATTENTION: always use low-foam detergent. To avoid the production of foam, put a minimum quantity of antifoam liquid in the recovery tank before starting to clean. Do not use pure acids.



ATTENTION: protective gloves should always be worn before handling detergents or acidic or alkaline solutions, to avoid serious injury to the hands.

16. FILLING THE DETERGENT CANISTER (only for systems with FSS)

After filling the solution tank with clean water, proceed as follows:

1. Do what is required to make sure the appliance is in a safe condition (see "[APPLIANCE SAFETY](#)").
2. Remove the cap (1) of the detergent canister (2).
3. Remove the detergent canister (2) from the solution tank compartment.
4. Fill the canister with the desired detergent, as shown on the label supplied with the appliance.



ATTENTION: protective gloves should always be worn before handling detergents or acidic or alkaline solutions, to avoid serious injury to the hands.



ATTENTION: always use low-foam detergent. To avoid the production of foam, put a minimum quantity of antifoam liquid in the recovery tank before starting to clean. Do not use pure acids.

ATTENTION: Always use detergents whose manufacturer's label indicates their suitability for scrubbing machines. Do not use acid or alkaline products or solvents without this indication.

PREPARING THE APPLIANCE

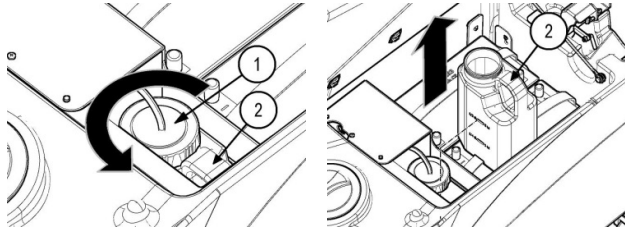

5. Put the canister (2) back into the solution tank compartment.
6. Tighten the screw cap (1) properly to prevent liquid leakage during operation, and ensure that the detergent suction filter (3) is correctly positioned at the bottom of the canister.
7. Grip the handle (4) on the rear left side of the recovery tank and turn the recovery tank until it reaches the work position.
8. Secure the recovery tank with the hinge (5).
9. Before starting to use the appliance for the first time, carefully read the paragraphs "[ADJUSTING THE DETERGENT \(only for FSS systems\)](#)" and "[TRIGGERING THE DOSING SYSTEM \(only for FSS systems\)](#)".



ATTENTION: the dosing system is suitable for frequent maintenance cleaning. acid or alkaline maintenance detergents can be used, as long as they have pH values between 4 and 10, and do not contain: oxidising agents, chlorine or bromine, formaldehyde, mineral solvents. The detergents used must be suitable for use with scrubbing machines. Wash the circuit with water after use if the system is not used daily. The system can be excluded. In case of sporadic use of detergents with pH between 1-3 or 11-14, use the floor scrubbing machine in the traditional way by adding the detergent in the clean water tank and excluding the dosing circuit.

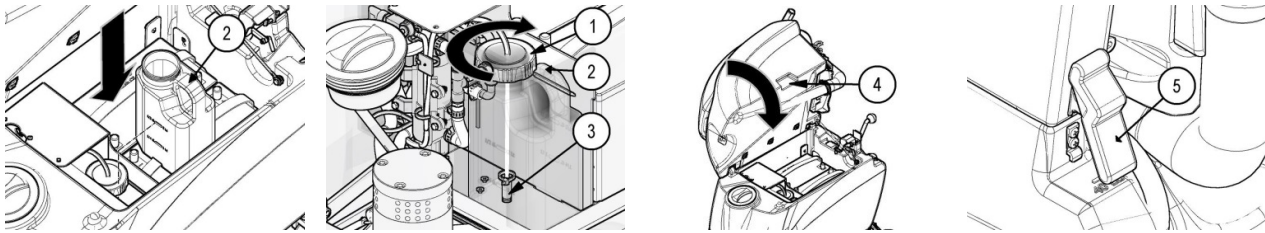

17. ASSEMBLING THE SQUEEGEE

For packaging reasons, the squeegee is supplied disassembled from the device, and must be assembled as follows:

1. Do what is required to make sure the appliance is in a safe condition (see "[APPLIANCE SAFETY](#)").



ATTENTION: these operations must be carried out using protective gloves to avoid any possible contact with the edges or tips of metal objects.

2. Grip the handle (1) on the rear left side of the recovery tank and turn the recovery tank until it reaches the work position.
3. Secure the recovery tank with the hinge (2).
4. Loosen the knobs (3) in the squeegee body pre-assembly.
5. First insert the left-hand squeegee pin on the squeegee body into the left-hand slit (4) of the squeegee connection, then tighten the knob (3), making sure that the washer (5) and spring adhere to the upper part of the squeegee support.
6. Insert the right-hand squeegee pin on the squeegee body into the right-hand slit (6) of the squeegee connection, then tighten the knob (3), making sure the washer (7) and spring adhere to the upper part of the squeegee support.
7. Tighten the handwheel (3) to lock the squeegee into place.
8. Finally, insert the vacuum hose (8) of the squeegee into the relative joint (9) of the vacuum nozzle.



ATTENTION: The squeegee has already been regulated, however if it needs adjusting, read the section "[ADJUSTING THE SQUEEGEE](#)".

PREPARING THE APPLIANCE

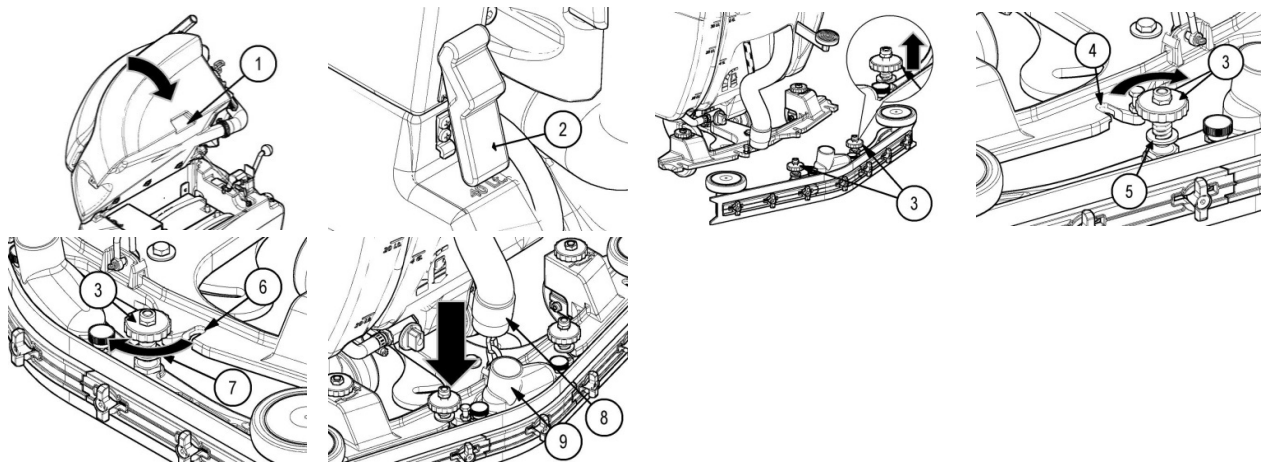

18. BRUSH ASSEMBLY (only for single-disc versions)

For packaging reasons, the brush is supplied disassembled from the device, and must be assembled as follows:

1. Take all necessary steps to ensure that the device is in a safe condition (see "[MACHINE SAFETY](#)").



ATTENTION: users are advised to always wear protective gloves, to avoid the risk of serious injury to hands.

2. Grip the handle (1) on the rear left side of the recovery tank and turn the recovery tank until it reaches the work position.
3. Secure the recovery tank with the hinge (2).
4. With the brush head detached from the floor, place the brush into the body underneath the brush head.
5. Lower the brush head unit positioning it onto the brush by activating the brush head unit control pedal (3).
6. Rotate the brush until the coupling system in the brush plate locks with the brush locking system (for MMx 43 versions).
7. Rotate the brush until the three buttons in the brush enter into the notches in the brush plate (for MMx 50 versions).
8. To lock, click them into position by turning them anticlockwise to the direction of travel.
9. For the MMx 43 version, reassemble the brush head splash guard (read the paragraph "[BRUSH HEAD SPLASH GUARD ASSEMBLY](#)").

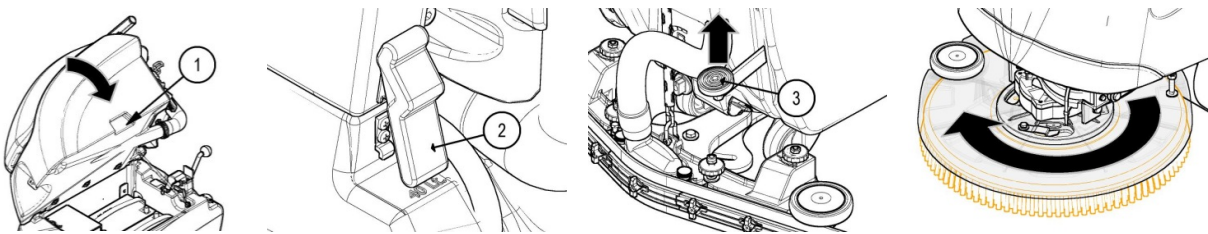

19. BRUSH ASSEMBLY (only for twin-disc versions)

For packaging reasons, brushes are supplied disassembled from the appliance, and must be assembled as follows:

1. Take all necessary steps to ensure that the device is in a safe condition (see "[MACHINE SAFETY](#)").
2. Grip the handle (1) on the rear left side of the recovery tank and turn the recovery tank until it reaches the work position.
3. Secure the recovery tank with the hinge (2).



ATTENTION: users are advised to always wear protective gloves, to avoid the risk of serious injury to hands.

4. With the brush head detached from the floor, place the brush into the body underneath the brush head.
5. Lower the brush head unit, positioning it onto the brushes by activating the brush head unit control pedal (3).
6. Rotate the brush until the brush's three buttons grip with the notches in the brush plate.
7. To lock, click them into position by turning them anticlockwise to the direction of travel for the right-hand brush and clockwise for the left-hand brush.
8. Reassemble the brush head splash guard (read the paragraph "[BRUSH HEAD SPLASH GUARD ASSEMBLY](#)").

PREPARING THE APPLIANCE

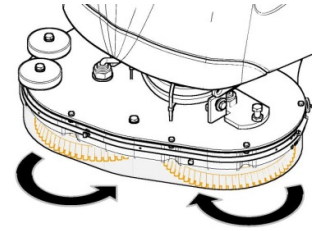
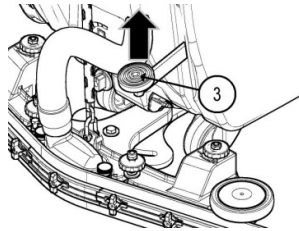
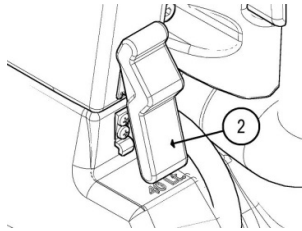
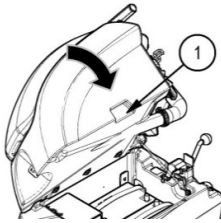

20. ASSEMBLING THE SPLASH GUARD BRUSH HEAD

For packaging reasons, the brush head splash guard is supplied disassembled from the device, and must be assembled as follows:

1. Take all necessary steps to ensure that the device is in a safe condition (see "[MACHINE SAFETY](#)").



ATTENTION: users are advised to always wear protective gloves, to avoid the risk of serious injury to hands.

2. Grip the handle (1) on the rear left side of the recovery tank and turn the recovery tank until it reaches the work position.
3. Secure the recovery tank with the hinge (2).
4. Lower the brush head unit, positioning it onto the brushes by activating the brush head unit control pedal (3).
5. Unhook the spring hook (4) from the fastening screw on the right-hand side of the brush head (direction of work).
6. Remove the fixing strip (5) of the rubber splash guard.
7. Wind the rubber splash guard (6) around the brush head, positioning it in such a way so as it is symmetrical to the brush, after first inserting it into the pin (7) located on the brush head's left-hand side (work direction).
8. Reposition the previously removed strip (5) and insert it into the pin (7) on the left-hand side of the brush head (work direction).
9. Unhook the spring hook (4) from the fastening screw (8) on the right-hand side of the brush head (direction of work).



ATTENTION: For the twin-disc version, repeat the operation for both strips.

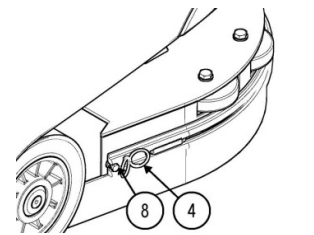
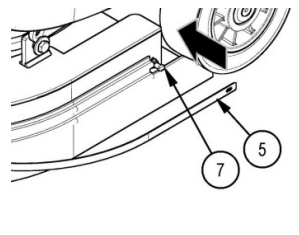
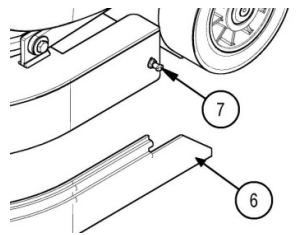
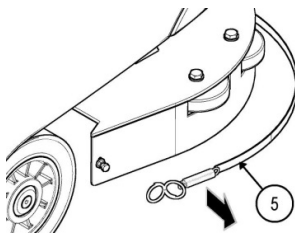
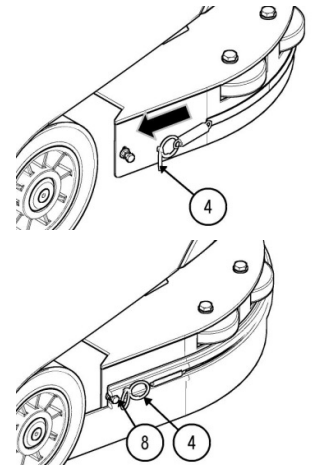
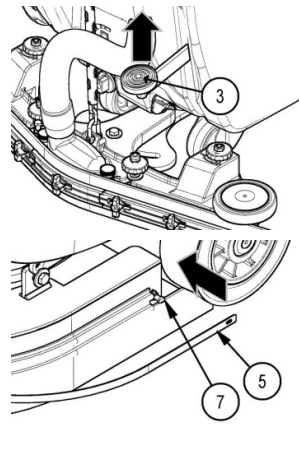
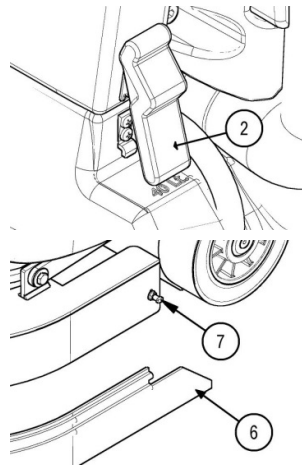
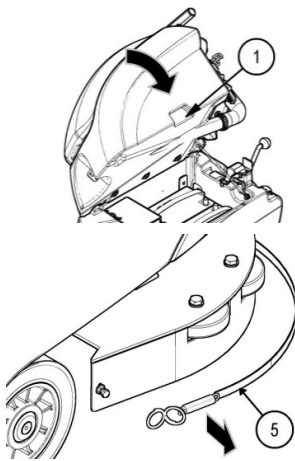

PREPARING TO WORK

1. PREPARING TO WORK

Before beginning to work, it is necessary to:

1. Make sure the recovery tank is empty, otherwise empty it completely (read "[EMPTYING THE RECOVERY TANK](#)").
2. Check that the suction motor filter has been correctly cleaned; if this is not the case, clean it (read the paragraph "[CLEANING THE SUCTION MOTOR FILTER FLOAT](#)").
3. Check that the solution tank filter has been correctly cleaned; if this is not the case, clean it (read the paragraph "[CLEANING THE SOLUTION TANK FILTER](#)").
4. Verify that the quantity of detergent solution in the solution tank is suitable for the type of work you wish to carry out, otherwise fill the solution tank (see the paragraph "[FILLING THE SOLUTION TANK](#)"). Check the level tube (1) on the rear left-hand side of the appliance.
5. Check that the state of the squeegee rubber blades are suitable for work, if not ensure the appropriate maintenance is carried out (read the sections "[CLEANING THE SQUEEGEE BODY](#)" or "[REPLACING THE SQUEEGEE RUBBER](#)"). Check that the squeegee's vacuum chamber and the relevant suction inlet have been properly cleaned (read paragraphs "[CLEANING THE SQUEEGEE BODY](#)").
6. Check that the condition of the brushes is suitable for working, if not have maintenance work carried out (read the paragraphs "[CLEANING BRUSH](#)" or else "[REPLACING BRUSH](#)").
7. Free the recovery tank using the hinge (2).
8. Grip the handle (3) on the rear left side of the recovery tank (work direction) and turn the recovery tank until it reaches the end position.
9. Check that the battery (4) is connected to general system connector (5); if not, connect them together.
10. Check that the amount of detergent in the canister (4) is suitable for the type of work you wish to carry out, if not, fill up with detergent (read the section "[FILLING THE DETERGENT CANISTER \(only for FSS versions\)](#)").
11. Grip the handle (3) on the rear left side of the recovery tank (work direction) and turn the recovery tank until it reaches the work position.
12. Secure the recovery tank with the hinge (2).
13. For BT versions, check that the parking brake is not on. If this is not the case, rotate the lever (6) in the sense shown by the picture.

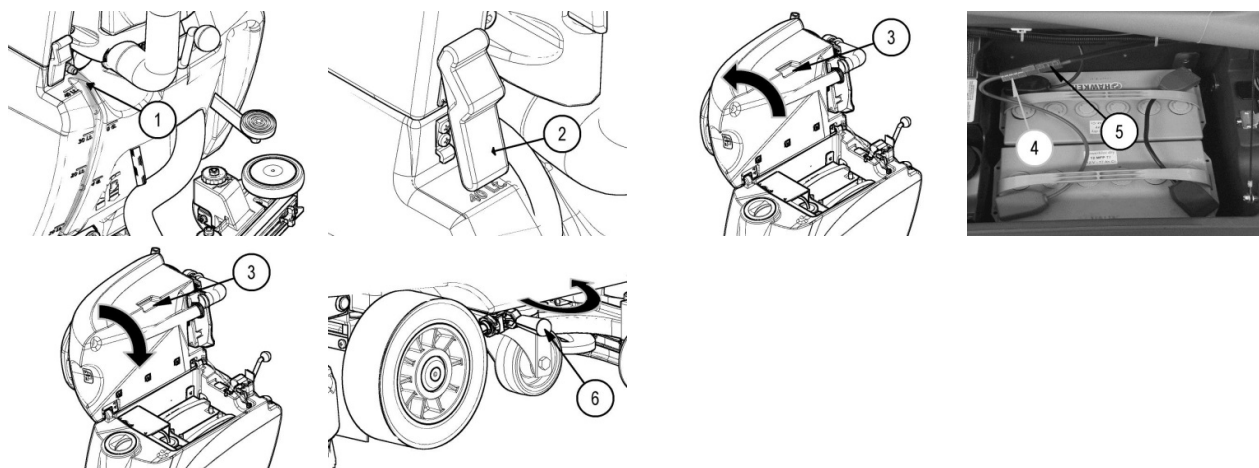

2. TRIGGERING THE DOSING SYSTEM (only for FSS system)

Before starting to work for the first time, or after a long period of appliance inactivity, it is necessary to proceed as follows:

1. Check that the water tap is fully turned on, turn the knob (1) to the left.
2. Check that the detergent solution tap (on the brush head unit) is in the active dosing system position; the lever (2) must be in a vertical position.
3. Turn the main machine switch to "I", turn the key (3) a quarter rotation to the right.
4. When the control display shows the work screen, turn the water flow knob (4) to the right, to the maximum flow position.

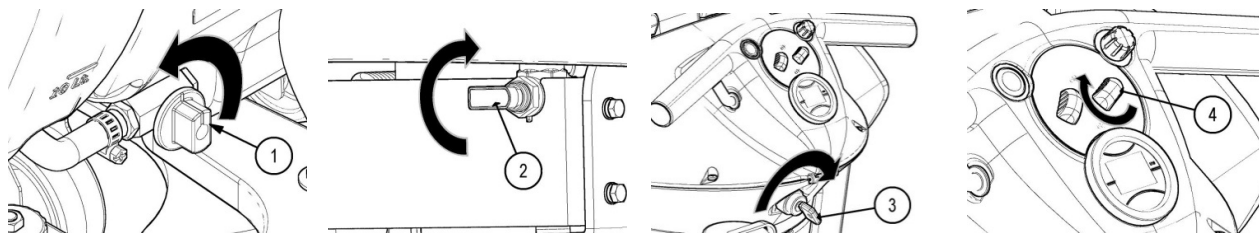

PREPARING TO WORK

5. Turn the detergent flow adjustment knob (5) to the left, to the maximum flow position.
6. Lower the brush head unit by actioning the pedal (6) located on the rear of the appliance.
7. Lower the brush head unit using the lever (7) on the rear of the appliance.
8. Action the dead man's levers (8) under the control handlebar, to allow activation of the appliance and the dosing system.
9. Wait a few moments keeping the dead man's levers pressed (normally 40 to 60 seconds) to allow the dosing system to be triggered.

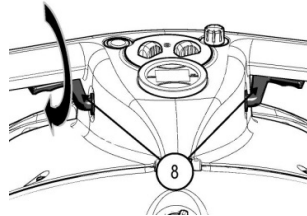
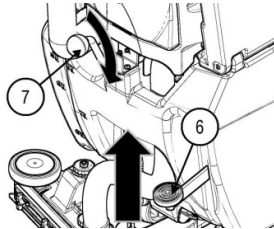
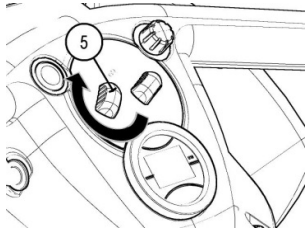

WORK

1. STARTING WORK

To start working, proceed as follows:

1. Make all the checks listed in [“PREPARING TO WORK”](#).
2. Turn the main machine switch to "I", turn the key (1) a quarter turn to the right. The control display on the control panel will immediately comes on.
3. Lower the brush head unit by pressing the pedal (2) located on the rear of the appliance.
4. Lower the brush head unit using the lever (3) on the rear of the appliance.
5. By pressing the dead man's levers (4) under the control handlebar, the appliance will start to operate in full efficiency conditions up until the detergent solution is depleted or the batteries are discharged.



ATTENTION: For BT versions, adjust forward speed (read the paragraph [“WORKING FORWARD SPEED \(only for systems without BT\)”](#)).

ATTENTION: when filling the solution tank, it is good practice to empty the recovery tank using the special drainage hose.

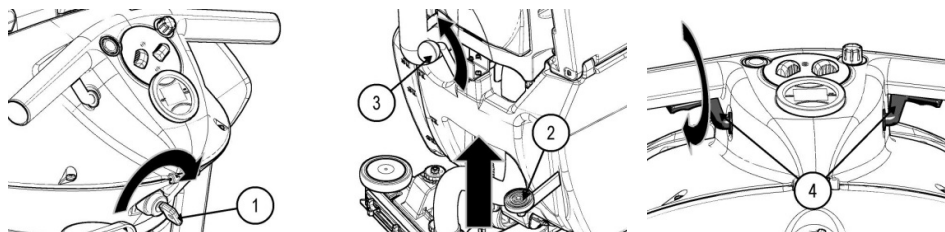

2. DETERGENT ADJUSTMENT (only for versions without FSS)

To regulate the amount of detergent solution on the brushes, proceed as follows:

1. Fully open the tap on the rear of the appliance by rotating the knob (1) on the rear of the device downwards.
2. By using the dead man's levers (2) both the brush motor and the suction motor will kick in and the solenoid valve will distribute the detergent solution to the brushes.
3. During the first few meters, check that the quantity of solution is enough to wet the floor, but not so much as to come out of the splash guard; the detergent disposal quantity can be adjusted by means of the knob (1) on the appliance's rear.



ATTENTION: In the event of malfunction of the water system, read the paragraph [“CLEANING THE SOLUTION TANK FILTER”](#).

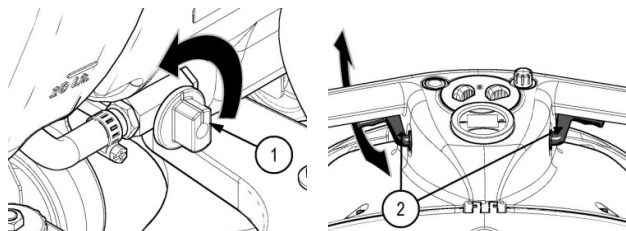

3. DETERGENT ADJUSTMENT (only for versions with FSS)

To regulate the amount of detergent solution on the brushes, proceed as follows:

1. Fully open the flow coming from the tap on the rear of the appliance by turning the lever (1) on the appliance's rear downwards.
2. By using the dead man's levers (2) both the brush motor and the suction motor will kick in and the solenoid valve will distribute the detergent solution to the brushes.
3. During the first few meters, check that the quantity of solution is enough to wet the floor, but not so much as to come out of the splash guard; the flow of detergent can be adjusted using the water flow adjustment knob (3) and the detergent flow adjustment knob (4) on the appliance's control panel.



ATTENTION: The quantity of water varies from a minimum of 30 litres/hour to a maximum of 70 litres/hour, with 7 dosing levels. The correct water flow must be selected depending on the type of flooring and must be proportional to the flooring's dirt conditions and forward speed. In addition, remember that the time available for continuous operation depends on the quantity of water in the tank

WORK

ATTENTION: The percentage of detergent in the solution varies from a minimum of 0.5 % to a maximum of 3.5 % with 7 set dosing levels. The correct flow of detergent should depend on the nature of the floor; it must be proportional to the intensity of dirt on the floor and the forward movement speed. In addition, remember that the time available for continuous working depends on the quantity of water in the tank.



ATTENTION: If the detergent solution supply pump does not work (only for version with FSS) read the paragraph ["BYPASSING THE WATER SYSTEM SUPPLY PUMP \(only for version with FSS\)"](#)

ATTENTION: In the event of water system malfunction, read the paragraph ["CLEANING THE SOLUTION TANK FILTER"](#) or ["CLEANING THE WATER SYSTEM FILTER \(only for MMx 50 versions\)"](#).

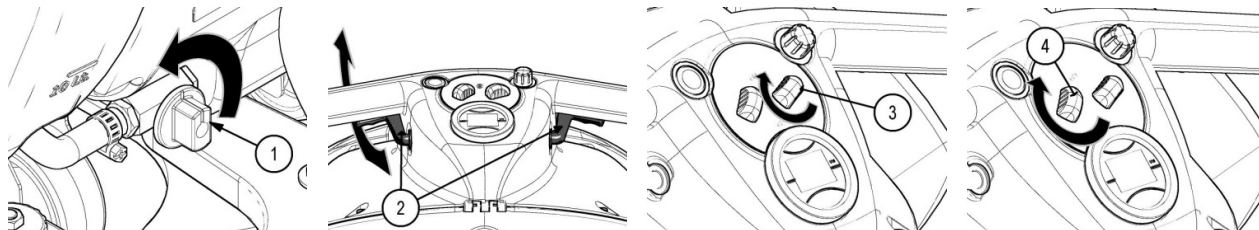

4. "ECO MODE" DEVICE

By activating the "ECO-MODE" function using the relevant button (1) on the control panel, the energy used by the appliance is reduced, decreasing the power of the brush motor and the suction motor. When the ECO-MODE program is activated, the wording "ECO" is displayed on the control display. To cancel the ECO-MODE program, just press the button again. The ECO-MODE function can only be activated during the washing and scrubbing phase (with brush head unit and squeegee head unit touching the floor) or during the drying phase (with brush head unit lifted and squeegee head unit touching the floor).



ATTENTION: Should the squeegee head unit be lifted in ECO-MODE mode, the suction mode would revert to "STANDARD" mode and continue to operate for a period of time, to then switch off automatically.

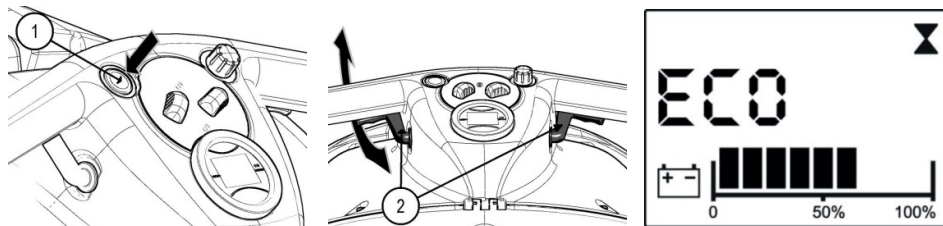

5. OVERFLOW DEVICE

The appliance is equipped with a mechanical device (float) under the recovery tank cap that, when the recovery tank is full, shuts off the air to the suction motor intake to protect it; the sound of the vacuum motor will then be deeper. If this is the case, proceed as follows:

1. Lift the brush head unit by using the pedal located on the appliance's rear.
2. Lift the squeegee body using the lever on the appliance's rear.
3. Take the appliance to the designated waste water drainage area and empty the recovery tank (read the paragraph ["EMPTYING THE RECOVERY TANK"](#) carefully first).

AT THE END OF THE WORK

At the end of the work, and before carrying out any type of maintenance, perform the following operations:

1. Take the appliance to the place where it is maintained and carry out all the procedures listed in the chapter "[DAILY MAINTENANCE](#)".
2. Take the appliance to the designated machine storage place.



ATTENTION: Park the appliance in an enclosed place, on a flat surface; near the appliance there must be no objects that could either damage it, or be damaged through contact with it.

3. Perform all the procedures listed in the paragraph "[ENSURING APPLIANCE SAFETY](#)".
4. Grip the handle (1) on the rear left side of the recovery tank and turn the recovery tank until it reaches the work position.
5. Secure the recovery tank with the hinge (2).



ATTENTION: At the end of the work, it is advised to turn the recovery tank cap to the maintenance position to prevent bad odours.

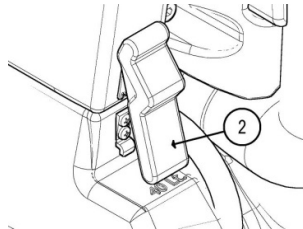
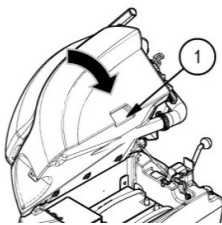

DAILY MAINTENANCE

PERFORM ALL MAINTENANCE OPERATIONS IN SEQUENCE

1. EMPTYING THE RECOVERY TANK

Proceed as follows to empty the recovery tank:

1. Take the appliance to the dedicated waste water drainage area.
2. Do what is required to make sure the appliance is in a safe condition (see "[APPLIANCE SAFETY](#)").
3. Grip the handle (1) on the rear left side of the recovery tank (work direction) and turn the recovery tank until it reaches the work position.
4. Secure the recovery tank with the hinge (2).
5. Remove the drainage hose (3) of the recovery tank from the clamps; it is located at the rear of the device.
6. Bend the end of the drainage tube, so as to create a choke and prevent the content from coming out, put the tube on the discharge surface and gradually release the tube.
7. Repeat the operations in reverse order to reassemble all the parts.



ATTENTION: users are advised to always wear protective gloves, to avoid the risk of serious injury to hands.

ATTENTION: The place given over to this operation must comply with current environmental protection regulations.

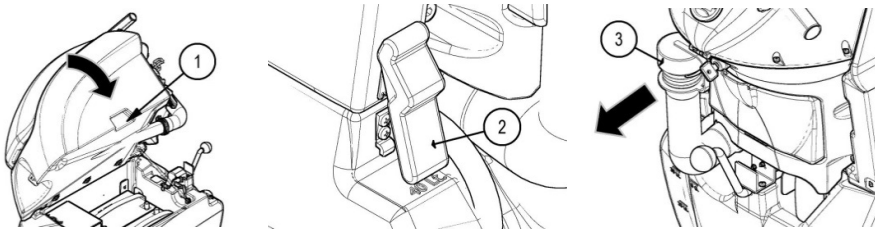

2. EMPTYING OF THE SOLUTION TANK

Proceed as follows to empty the solution tank:

1. Take the appliance to the dedicated waste water drainage area.
2. Do what is required to make sure the appliance is in a safe condition (see "[APPLIANCE SAFETY](#)").
3. Grip the handle (1) on the rear left side of the recovery tank (work direction) and turn the recovery tank until it reaches the work position.
4. Secure the recovery tank with the hinge (2).
5. Close the flow coming from the tap on the rear of the appliance by turning the knob (3) on the rear of the appliance downwards.
6. Unscrew the solution tank lid (4) located on the rear of the appliance.
7. Repeat the operations in reverse order to reassemble all the parts.



ATTENTION: users are advised to always wear protective gloves, to avoid the risk of serious injury to hands.

ATTENTION: The place given over to this operation must comply with current environmental protection regulations.

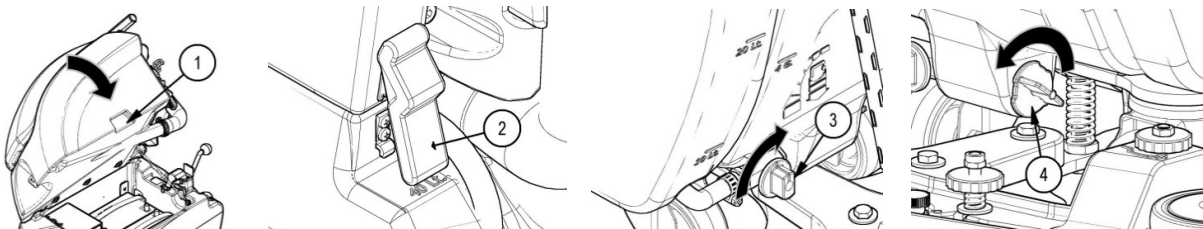

3. CLEANING THE SQUEEGEE BODY

The careful cleaning of the whole vacuum unit ensures better drying and cleaning of the floor as well as a longer suction motor life. To clean the squeegee unit, proceed as follows:

1. Take the device to the dedicated maintenance area.
2. Do what is required to make sure the appliance is in a safe condition (see "[APPLIANCE SAFETY](#)").
3. Grip the handle (1) on the rear left side of the recovery tank (work direction) and turn the recovery tank until it reaches the work position.
4. Secure the recovery tank with the hinge (2).
5. Remove the vacuum hose (3) from the vacuum nozzle (4) on the squeegee body.
6. Loosen the knobs (5) in the squeegee body pre-assembly.
7. Remove the squeegee body from the slits in the squeegee connector.
8. First with a jet of water and then with a damp cloth, thoroughly clean the vacuum chamber (6) of the squeegee unit.

DAILY MAINTENANCE



ATTENTION: users are advised to always wear protective gloves, to avoid the risk of serious injury to hands.

ATTENTION: The place given over to this operation must comply with current environmental protection regulations.

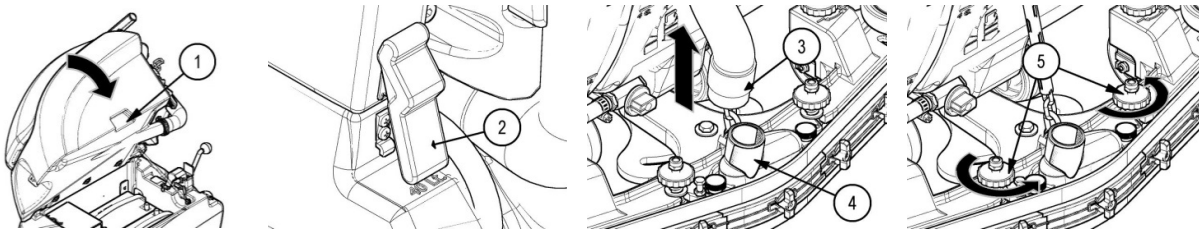

9. First with a jet of water and then with a damp cloth, thoroughly clean the front rubber blade (7) of the squeegee body.
10. Check the wear of the front rubber blade (7) on the squeegee body; if the edge of the rubber that is in contact with the floor is worn replace it, reading the paragraph "[REPLACING THE SQUEEGEE UNIT RUBBER BLADES](#)".
11. First with a jet of water and then with a damp cloth, thoroughly clean the rear rubber blade (8) of the squeegee body.
12. Check the wear of the rear rubber blade (8) on the squeegee body; if the edge of the rubber that is contact with the floor is worn, replace it, reading the paragraph "[REPLACING THE SQUEEGEE RUBBER BLADES](#)" first; in any event it is possible to turn the rubber blade around four edges.
13. Tighten the knobs (9) that fix the vacuum nozzle (4) to the squeegee body.
14. First with a jet of water and then with a damp cloth, thoroughly clean the vacuum nozzle (4). Also clean the squeegee body support surface.
15. Repeat the operations in reverse order to reassemble all the parts.

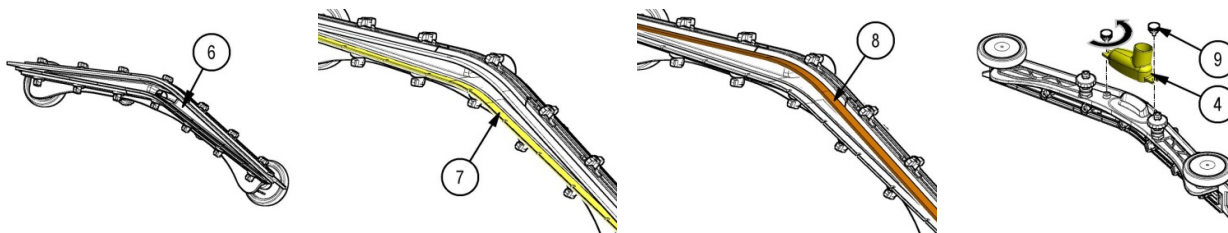

4. CLEANING THE BRUSH

Careful cleaning of the brush guarantees better cleaning of the floor as well as a longer brush motor life. To clean the brush, proceed as follows:

1. Take the device to the dedicated maintenance area.
2. Do what is required to make sure the appliance is in a safe condition (see "[APPLIANCE SAFETY](#)").
3. Grip the handle (1) on the rear left side of the recovery tank (work direction) and turn the recovery tank until it reaches the work position.
4. Secure the recovery tank with the hinge (2).
5. Press the brush release button (3) on the control panel. As soon as the button is pressed, the letter "S" will be displayed on the work screen. Press the brush release button (3) again to confirm (**applies to single-disc versions only**). For twin-disc machines, rotate individual brushes manually until they are dislodged from their housing in the brush plate.
6. Clean the brush under running water to remove any impurities from its bristles. Check that the bristles are not worn; in the event of excessive wear, replace the brush (the bristles should be at least 10 mm long). Read the paragraph "[REPLACING THE BRUSH](#)" to replace the brush.
7. Repeat the operations in reverse order to reassemble all the parts.

ATTENTION: users are advised to always wear protective gloves, to avoid the risk of serious injury to hands.



ATTENTION: The place given over to this operation must comply with current environmental protection regulations.

ATTENTION: For twin-disc versions it is recommended to switch the right and left brush on a daily basis and vice-versa. If the brushes are not new however, and have deformed bristles, it is better to reassemble them in the same position (the right-hand one on the right, and the left-hand one on the left), to prevent the different inclination of the bristles producing an overload on the brush motor as well as excessive vibrations.

DAILY MAINTENANCE

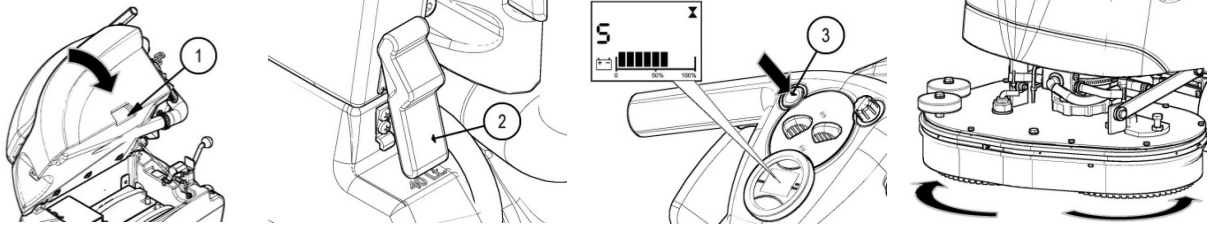

5. CLEANING THE SUCTION MOTOR FILTER FLOAT

Careful cleaning of the recovery tank filter guarantees better cleaning of the floor as well as a longer suction motor life. Proceed as follows to clean the recovery tank filter:

1. Take the device to the dedicated maintenance area.
2. Do what is required to make sure the appliance is in a safe condition (see "[APPLIANCE SAFETY](#)").
3. Grip the handle (1) on the rear left side of the recovery tank (work direction) and turn the recovery tank until it reaches the work position.
4. Secure the recovery tank with the hinge (2).
5. Grip the handle (3) on the front side of the vacuum cap, rotate the vacuum cap until the hook (4) is secured to the recovery tank's prop (5).
6. Remove the vacuum filter protection (6) by rotating it in a clockwise direction. Release the retaining clips (7). Take the vacuum filter out of the housing (8), clean the walls and the bottom of the filter with a jet of water, remove any dirt that is attached.
7. Repeat the operations in reverse order to reassemble all the parts.



ATTENTION: users are advised to always wear protective gloves, to avoid the risk of serious injury to hands.

ATTENTION: The place given over to this operation must comply with current environmental protection regulations.

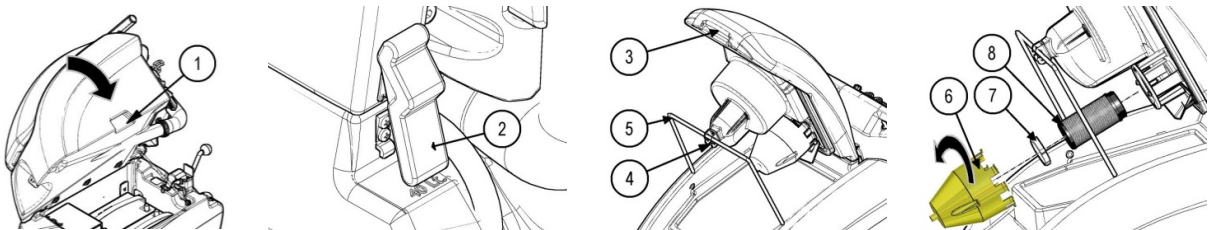

6. CLEANING THE SOLUTION TANK FILTER

The careful cleaning of the solution tank filter guarantees a longer life span of the appliance's water circuit system, ensuring a better floor cleaning performance. Proceed as follows to clean the solution tank's filter:

1. Take the device to the dedicated maintenance area.
2. Do what is required to make sure the appliance is in a safe condition (see "[APPLIANCE SAFETY](#)").
3. Grip the handle (1) on the rear left side of the recovery tank (work direction) and turn the recovery tank until it reaches the work position.
4. Secure the recovery tank with the hinge (2).
5. Loosen the drain cap (3) and clean it with clean running water; where needed, remove any impurities from it.
6. Repeat the operations in reverse order to reassemble all the parts.



ATTENTION: users are advised to always wear protective gloves, to avoid the risk of serious injury to hands.

ATTENTION: The place given over to this operation must comply with current environmental protection regulations.

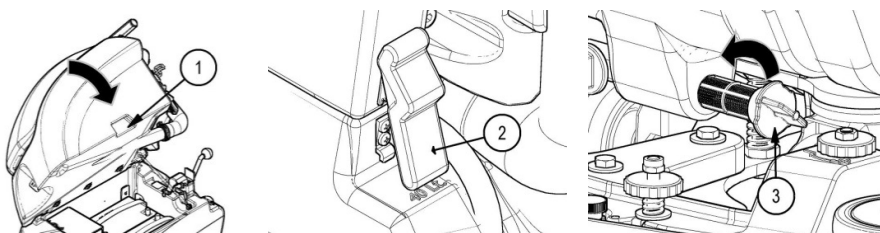

WEEKLY MAINTENANCE

1. CLEANING THE RECOVERY TANK

The careful cleaning of the recovery tank guarantees a longer appliance life span. Proceed as follows to clean the recovery tank:

1. Take the device to the dedicated maintenance area.
2. Do what is required to make sure the appliance is in a safe condition (see "[APPLIANCE SAFETY](#)").
3. Grip the handle (1) on the rear left side of the recovery tank (work direction) and turn the recovery tank until it reaches the work position.
4. Secure the recovery tank with the hinge (2).
5. Remove the recovery tank's drainage hose (3) from the clamps, located at the rear of the appliance; unscrew the cap and place it on the ground.
6. Grip the handle (4) on the front side of the vacuum cap, rotate the vacuum cap until the hook (5) is secured to the recovery tank's prop (6).
7. Rinse the inside with a jet of water, if necessary use a spatula to remove the sludge that has accumulated at the bottom of the tank.
8. Repeat the operations in reverse order to reassemble all the parts.



ATTENTION: users are advised to always wear protective gloves, to avoid the risk of serious injury to hands.

ATTENTION: The place given over to this operation must comply with current environmental protection regulations.

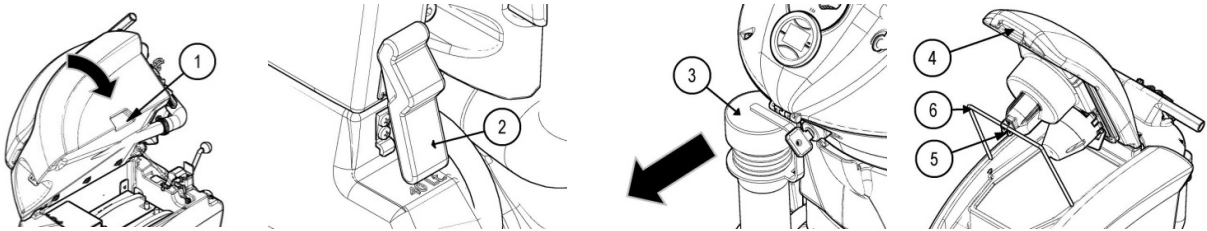

2. CLEANING THE SOLUTION TANK

The careful cleaning of the solution tank guarantees a longer appliance life span. Proceed as follows to clean the solution tank:

1. Take the device to the dedicated maintenance area.
2. Do what is required to make sure the appliance is in a safe condition (see "[APPLIANCE SAFETY](#)").
3. Grip the handle (1) on the rear left side of the recovery tank (work direction) and turn the recovery tank until it reaches the work position.
4. Secure the recovery tank with the hinge (2).
5. Check that the detergent solution tap is off; rotate the lever (3) on the rear of the appliance to the right (work direction).
6. Loosen the solution tank cap (4) and clean it with clean running water; where needed, remove any impurities from it.
7. Remove the filling cap (5) and the filter (6) on the front of the appliance. Clean the filter (6) with a jet of water and remove any dirt.
8. Rinse the inside of the solution tank with a jet of water.
9. Repeat the operations in reverse order to reassemble all the parts.



ATTENTION: users are advised to always wear protective gloves, to avoid the risk of serious injury to hands.

ATTENTION: The place given over to this operation must comply with current environmental protection regulations.

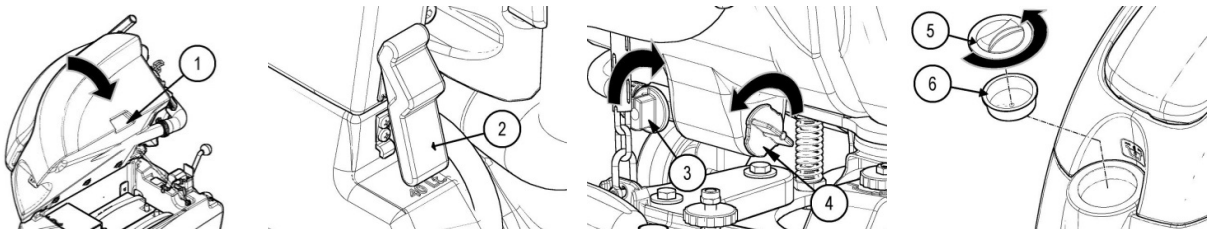

WEEKLY MAINTENANCE

3. CLEANING THE VACUUM HOSE

Careful cleaning of the vacuum hose guarantees better cleaning of the floor as well as a longer suction motor life. Proceed as follows to clean the vacuum hose:

1. Take the device to the dedicated maintenance area.
2. Do what is required to make sure the appliance is in a safe condition (see [“APPLIANCE SAFETY”](#)).
3. Grip the handle (1) on the rear left side of the recovery tank (work direction) and turn the recovery tank until it reaches the work position.
4. Secure the recovery tank with the hinge (2).
5. Remove the vacuum hose (3) from the vacuum nozzle (4) on the squeegee body.
6. Grip the handle (5) on the front side of the vacuum cap, rotate the cap (6) until the hook (7) is secured to the recovery tank's prop (8).
7. Clean the inside with a jet of water, inserting the hose in the part of the vacuum nozzle (8) fixed to the recovery tank.
8. Repeat the operations in reverse order to reassemble all the parts.



ATTENTION: users are advised to always wear protective gloves, to avoid the risk of serious injury to hands.

ATTENTION: The place given over to this operation must comply with current environmental protection regulations.

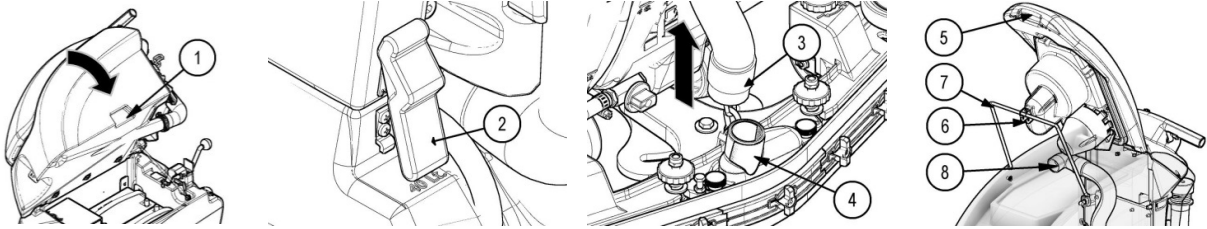

4. CLEANING THE DETERGENT CANISTER (only for system with FSS)

Careful cleaning of the detergent canister ensures improved floor cleaning performance as well as a longer water circuit system life span. To clean the canister, proceed as follows:

1. Do what is required to make sure the appliance is in a safe condition (see [“APPLIANCE SAFETY”](#)).
2. Remove the cap (1) of the detergent canister (2).
3. Remove the detergent canister (2) from the solution tank compartment.
4. Rinse the inside of the canister with a jet of running water.
5. Repeat the operations in reverse order to reassemble all the parts.



ATTENTION: The place given over to this operation must comply with current environmental protection regulations.

ATTENTION: Do not throw the detergent directly into the drain, but comply with current environmental protection regulations.

ATTENTION: Screw on the cap (1) of the detergent canister (2), making sure that the detergent suction filter (3) is correctly positioned on the bottom of the canister.

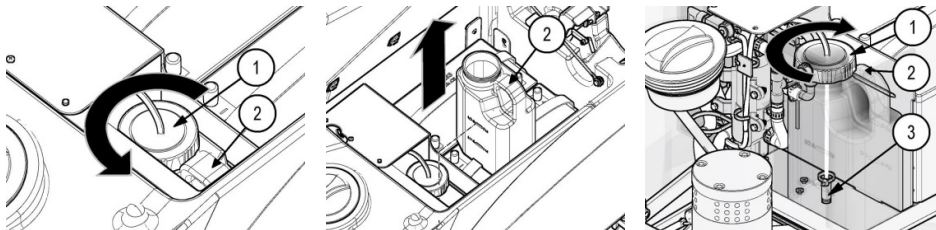

EXTRAORDINARY MAINTENANCE

1. REPLACING THE SQUEEGEE RUBBERS

The good condition of the squeegee rubber ensures improved drying and cleaning of the floor, as well as a longer suction motor life. To replace the squeegee rubber, proceed as follows:

1. Take the device to the dedicated maintenance area.
2. Do what is required to make sure the appliance is in a safe condition (see [“APPLIANCE SAFETY”](#)).
3. Grip the handle (1) on the rear left side of the recovery tank (work direction) and turn the recovery tank until it reaches the work position.
4. Secure the recovery tank with the hinge (2).
5. Remove the vacuum hose (3) from the vacuum nozzle (4) on the squeegee body.
6. **Fully** loosen the knobs (5) in the squeegee body pre-assembly.
7. Remove the squeegee body from the slits in the squeegee connector.



ATTENTION: users are advised to always wear protective gloves, to avoid the risk of serious injury to hands.

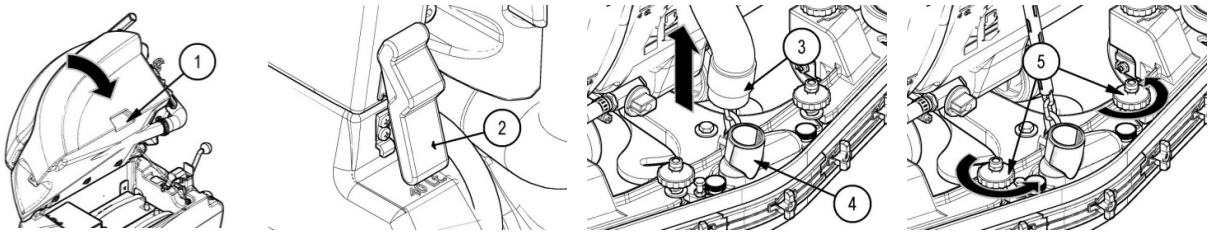

Proceed as follows for replacing the front rubber blade of the squeegee body:

1. Turn the wing nuts (6) in the horizontal position.
2. Remove the front rubber-pressing blades (7).
3. Remove the rubber (8) and replace it.
4. Proceed in reverse to replace the rubber.

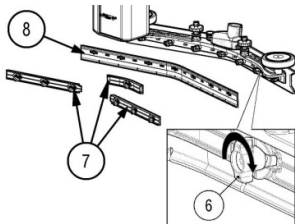

Proceed as follows for replacing the rear rubber blade of the squeegee body:

1. Turn the wing nuts (9) in the horizontal position.
2. Remove the rear rubber-pressing blades (10).
3. Remove the rubber (11) and replace it or turn it over.
4. Proceed in reverse to replace the rubber.

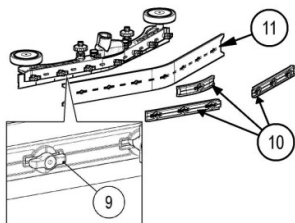

EXTRAORDINARY MAINTENANCE

2. ADJUSTING THE SQUEEGEE

Careful adjustment of the height between the squeegee rubber and the floor guarantees better drying and cleaning of the flooring as well as a longer suction motor life. To adjust the squeegee rubber, proceed as follows:

1. Take the device to the dedicated maintenance area.
2. Turn the main machine switch to "I", turn the key (1) a quarter turn to the right.
3. Lower the brush head unit by pressing the pedal (2) located on the rear of the appliance.
4. Lower the brush head unit using the lever (3) on the rear of the appliance.
5. Adjust the detergent solution flow (read the paragraphs "[REGULATING THE DETERGENT \(only for systems without FSS\)](#)" or "[REGULATING THE DETERGENT \(only for systems with FSS\)](#)")
6. By pressing the dead man's levers (4) under the control handlebar, the appliance will start to operate.

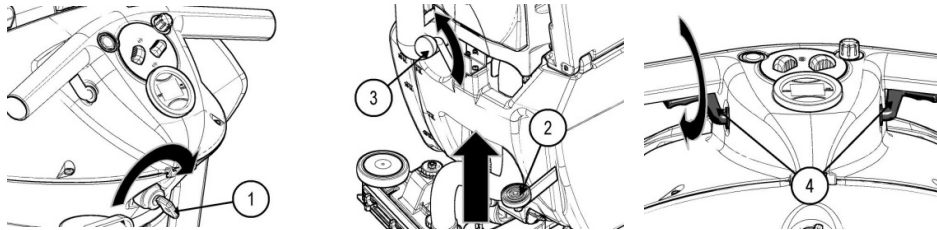

If you need to increase the inclination of the rubber blade in the centre, it is necessary to tighten the screw (5), while to decrease it just turn the screw (5) in the opposite direction. During working operation, the rear rubber blade should be slightly tilted backwards by about 30°- 45° with respect to the floor in a uniform way along its whole length. This means that the height of the squeegee should be regulated, and this is done by turning the knob (6) (in the diagram only the right knob is depicted) anti-clockwise to raise the squeegee and in the opposite direction to lower it.



ATTENTION: the right and left wheels must be adjusted to the same level, so the squeegee can work parallel to the floor.

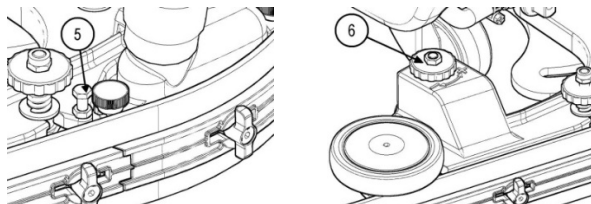

3. REPLACING THE BRUSH

The brush's integrity ensures better floor cleaning, as well as a longer brush motor life span. To replace the brush, proceed as follows:

1. Take the device to the dedicated maintenance area.
2. Do what is required to make sure the appliance is in a safe condition (see "[APPLIANCE SAFETY](#)").
3. Grip the handle (1) on the rear left side of the recovery tank (work direction) and turn the recovery tank until it reaches the work position.
4. Secure the recovery tank with the hinge (2).
5. Press the brush release button (3) on the control panel. As soon as the button is pressed, the letter "S" will be displayed on the work screen. Press the brush release button (3) again to confirm (**applies to single-disc machines only**). For twin-disc machines, rotate the individual brush manually until it is dislodged from its housing in the brush plate.
6. Replace the old brush with a new one (read paragraph "[ASSEMBLING THE BRUSH \(only for single-disc versions\)](#)" or "[ASSEMBLING THE BRUSH \(only for twin-disc versions\)](#)").



ATTENTION: users are advised to always wear protective gloves, to avoid the risk of serious injury to hands.

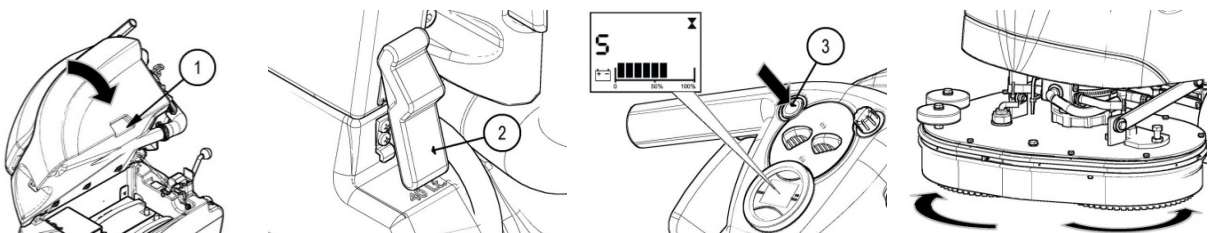

EXTRAORDINARY MAINTENANCE

4. REPLACING THE BRUSH HEAD SPLASH GUARD

The brush head splash guard's integrity ensures better floor cleaning performance, as well as a longer brush motor life span. To replace the brush head splash guard, proceed as follows:

1. Take all necessary steps to ensure that the device is in a safe condition (see "[MACHINE SAFETY](#)").



ATTENTION: users are advised to always wear protective gloves, to avoid the risk of serious injury to hands.

2. Grip the handle (1) on the rear left side of the recovery tank and turn the recovery tank until it reaches the work position.
3. Secure the recovery tank with the hinge (2).
4. Lower the brush head unit, positioning it onto the brushes by activating the brush head unit control pedal (3).
5. Unhook the spring hook (4) from the fastening screw on the right-hand side of the brush head (direction of work).
6. Remove the fixing strip (5) of the rubber splash guard.
7. Replace the old splash guard with the new one (read paragraph "[ASSEMBLING THE BRUSH HEAD SPLASH GUARD](#)").

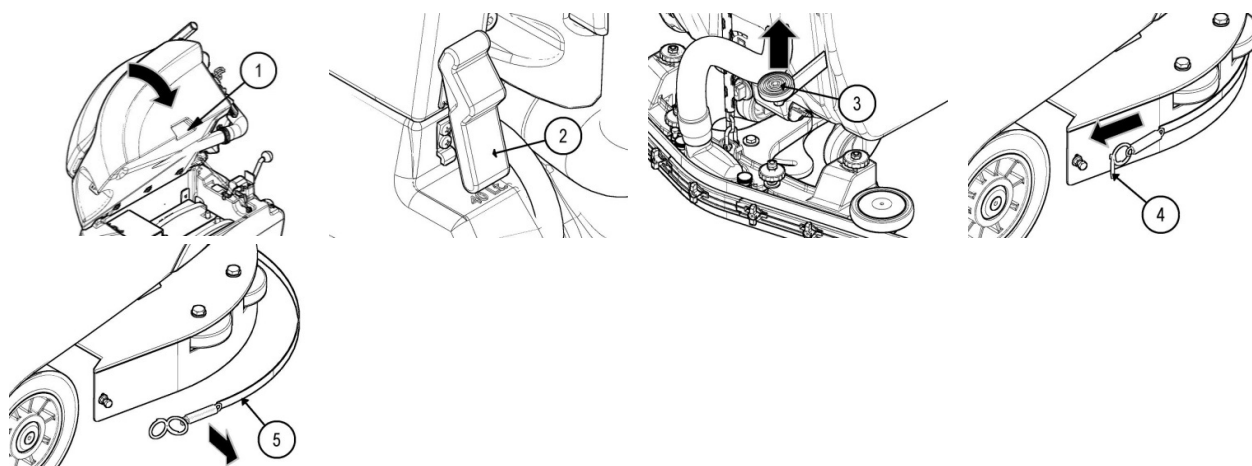

5. RINSING THE DOSING SYSTEM (only for FSS system)

If the appliance is not used for long periods of time (more than 48 hours), it is recommended that the dosing system should be rinsed. To do this, proceed as follows:

1. Take the device to the dedicated maintenance area.
2. Do what is required to make sure the appliance is in a safe condition (see "[APPLIANCE SAFETY](#)").
3. Remove the cap (1) of the detergent canister (2).
4. Remove the detergent canister (2) from the solution tank compartment.
5. Remove any detergent residue. Rinse the inside of the canister with a jet of running water. Fill the canister with clean water
6. Tighten the screw cap (1) properly to prevent liquid from leaking during operation, and ensure that the detergent suction filter (3) is correctly positioned at the bottom of the canister.
7. Put the canister (2) back into the solution tank compartment.



ATTENTION: The place given over to this operation must comply with current environmental protection regulations.

ATTENTION: Do not throw the detergent directly into the drain, but comply with current environmental protection regulations.

ATTENTION: users are advised to always wear protective gloves, to avoid the risk of serious injury to hands.

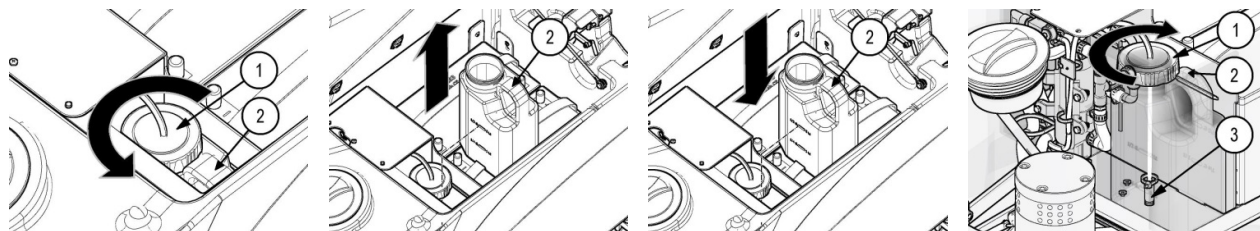

EXTRAORDINARY MAINTENANCE

8. Connect the battery connector (4) to the general system connector (5).
9. Grip the handle (6) on the rear left side of the recovery tank and turn the recovery tank until it reaches the work position.
10. Secure the recovery tank with the hinge (7).
11. Make sure the solution tank is full, if not, fill it up (read the section "[FILLING THE SOLUTION TANK WITH WATER](#)"). Check the level indicator (8) on the rear left-hand side of the appliance.
12. Check that the water tap is fully turned on, turn the knob (9) to the left.
13. Check that the detergent solution tap (on the brush head unit) is in the active dosing system position; the lever (10) must be in a vertical position.
14. Turn the main machine switch to "I", turn the key (11) a quarter rotation to the right.
15. When the control display shows the working screen, turn the water flow knob (12) to the right, to the maximum flow position.
16. Turn the detergent flow adjustment knob (13) to the left, to the maximum flow position.
17. Lower the brush head unit by pressing the pedal (14) located on the rear of the appliance.
18. Lower the brush head unit using the lever (15) on the rear of the appliance.
19. Action the dead man's levers (16) under the control handlebar, to allow activation of the appliance and the dosing system.
20. Wait a few moments keeping the dead man's levers pressed (normally 40 to 60 seconds) to allow the dosing system to be triggered.

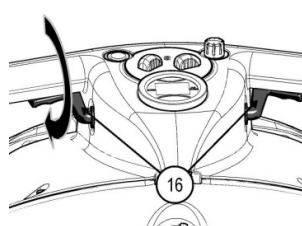
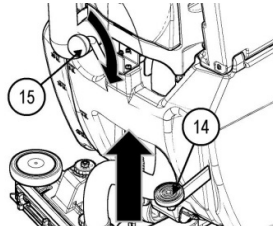
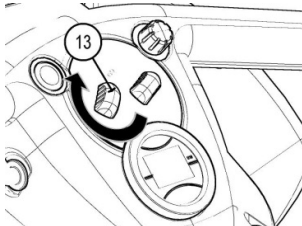
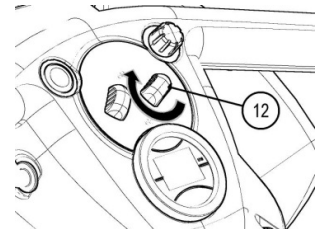
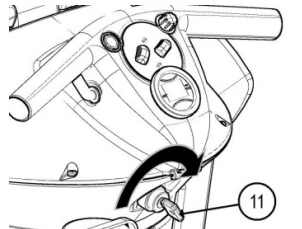
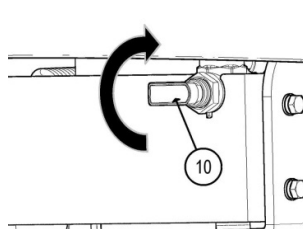
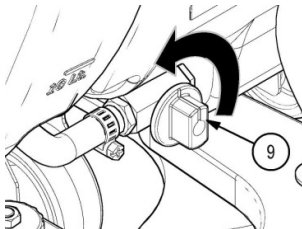
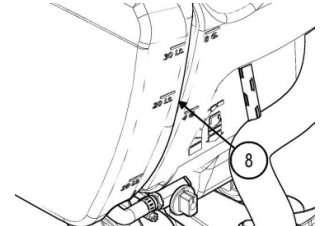
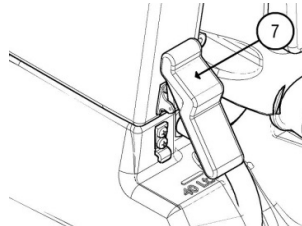
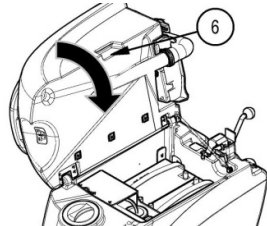
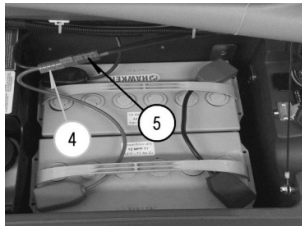

TROUBLESHOOTING

1. AN ALARM MESSAGE APPEARS ON THE CONTROL DISPLAY

If, when starting or using the appliance, a warning message appears on the control display, stop the appliance immediately and contact the technician at the dedicated Technical Service Centre.

2. THE APPLIANCE DOESN'T SWITCH ON

1. Check that the main switch is in the "I" position; if this is not the case, turn the key (1) by a quarter of a turn to the right.
2. Make sure that, when starting the machine, NO alarm message appears on the control display; read the paragraph ["AN ALARM MESSAGE APPEARS ON THE CONTROL DISPLAY"](#).
3. Check that the battery (2) is connected to general system connector (3); if not, connect them together.
4. Check the battery charge level, check the symbol on the command display. If the charge level of batteries is critical, go through a full charge cycle (read the paragraph ["CONNECTING BATTERIES \(only for systems without battery charger\)"](#) or ["CONNECTING BATTERY CHARGER \(only for systems with battery charger\)"](#)).



ATTENTION: If all these procedures do not solve the problem, contact the technician at the dedicated Technical Service Centre.

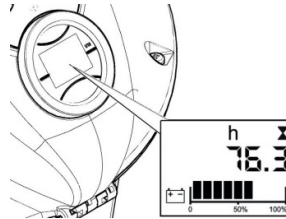
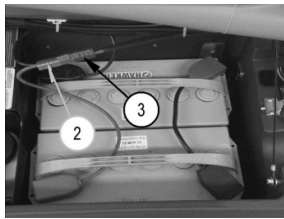
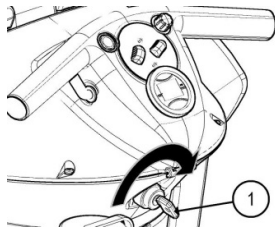

3. THE BATTERIES ARE NOT CHARGED CORRECTLY

1. Check that the battery (1) is connected to general system connector (2); if not, connect them together.
2. Check that the battery charger used is suitable for the batteries in the appliance and is correctly set up for the batteries used.
3. Referring to the battery charger use and maintenance manual, check the meaning of the flashing signals that the battery charger emits during the battery recharge stage.



ATTENTION: If all these procedures do not solve the problem, contact the technician at the dedicated Technical Service Centre.

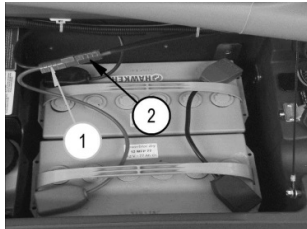

4. THE DEVICE HAS A VERY LOW OPERATING AUTONOMY

1. Check that there is water in the solution tank; the level in the tank checked using a level indicator (1) on the left rear of the device.
2. Check the battery charge level, check the symbol on the command display. If the charge level of batteries is critical, go through a full charge cycle (read the paragraph ["CONNECTING BATTERIES \(only for systems without battery charger\)"](#) or ["CONNECTING BATTERY CHARGER \(only for systems with battery charger\)"](#)).

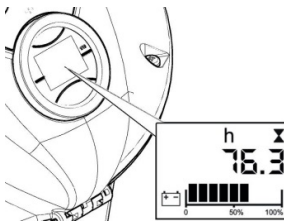
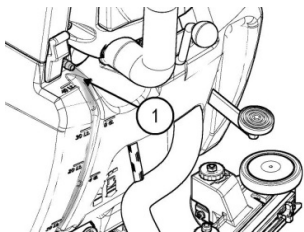

TROUBLESHOOTING

5. THE APPLIANCE DOES NOT MOVE

1. Make sure that the appliance switches on correctly; see paragraph ["THE APPLIANCE DOES NOT SWITCH ON"](#).
2. Check that the dead man's microswitches are active, action the dead man's levers (1) below the handlebar control.
3. In the traction versions, check that the forward speed adjustment knob (2) is not set to the minimum; if this is the case, read the paragraph ["FORWARD MOVEMENT AT WORK SPEED \(only for system with BT\)"](#).

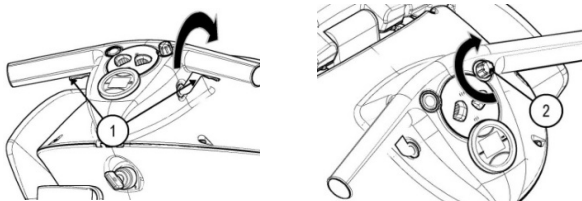

6. INSUFFICIENT WATER ON THE BRUSHES

1. Check that there is water in the solution tank; the level in the tank checked using a level indicator (1) on the left rear of the device.
2. Check that the detergent solution tap is open, check that the lever (2) on the rear of the appliance is fully rotated to the left of the appliance (work direction).
3. Check that the detergent solution tap (on the brush head unit) is in the active dosing system position; the lever (3) must be fully set to a vertical position.
4. In the FSS versions, check that the water flow in the water system is not set to zero; with the appliance on, turn the knob to the right (work direction).
5. In the FSS versions, check that the detergent flow in the water system is not set to zero; with the appliance on, turn the knob to the right (work direction).
6. Clean the solution tank filter (6) on the rear of the appliance (read the paragraph ["CLEANING THE SOLUTION TANK FILTER"](#)).

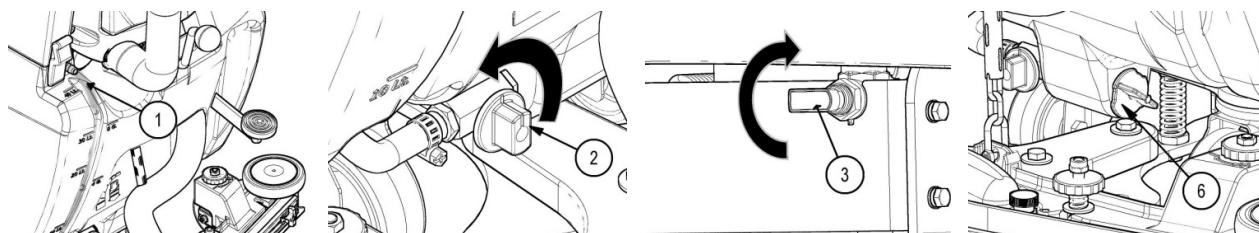

7. THE DEVICE DOES NOT CLEAN CORRECTLY

1. Make sure that the appliance switches on correctly; see paragraph ["THE APPLIANCE DOES NOT SWITCH ON"](#).
2. Make sure that the detergent solution is supplied correctly to the brushes, see the paragraph ["INSUFFICIENT WATER ON THE BRUSHES"](#).
3. Make sure that the amount of detergent solution (versions without FSS) or the amount of water and detergent (versions with FSS) in the appliance's water system is suitable for the work to be performed. Read the paragraph ["REGULATING THE DETERGENT \(only for systems without FSS\)"](#) or ["REGULATING THE DETERGENT \(only for systems with FSS\)"](#).
4. Make sure that the brushes fitted on the appliance are suitable for the task to be performed; read the section ["CHOOSING AND USING THE BRUSHES"](#).
5. Check the state of wear and tear of the brushes and, if necessary, replace them. The brushes should be changed when the bristles are about 15 mm long. To replace them, read the paragraph ["REPLACING THE BRUSH"](#). Working with over-worn brushes may cause damage to the floor.



ATTENTION: If all these procedures do not solve the problem, contact the technician at the dedicated Technical Service Centre.

8. THE SQUEEGEE DOES NOT DRY PERFECTLY

1. Make sure that the squeegee is clean (read paragraph ["CLEANING THE SQUEEGEE BODY"](#)).
2. Check the squeegee adjustments (read the section ["SQUEEGEE ADJUSTMENT"](#)).
3. Clean the entire vacuum unit (see paragraphs ["CLEANING THE SQUEEGEE BODY"](#), ["CLEANING THE VACUUM HOSE"](#), ["CLEANING THE SUCTION MOTOR FILTER FLOAT"](#)).
4. Replace the rubber blades if worn out (read the section ["REPLACING THE SQUEEGEE RUBBER BLADES"](#)).
5. Check that the cap on the recovery tank drainage hose is properly closed.
6. Make sure that the suction cover is correctly positioned.



ATTENTION: If all these procedures do not solve the problem, contact the technician at the dedicated Technical Service Centre.

TROUBLESHOOTING

9. EXCESSIVE FOAM PRODUCTION (RECOVERY TANK)

Check that a low foam detergent has been used. If necessary, add a small quantity of anti-foam liquid to the recovery tank. Remember that, when the floor is not very dirty, more foam is generated. In this case the detergent solution should be more diluted.

10. THE VACUUM MOTOR DOES NOT FUNCTION

1. Check whether the recovery tank is full and, if necessary, empty it.
2. Verify proper functioning of the float inside the recovery tank (read the paragraphs "[CLEANING THE RECOVERY TANK](#)" and "[CLEANING THE FLOAT - SUCTION MOTOR FILTER](#)").

11. BYPASSING THE WATER SYSTEM SUPPLY PUMP (only for FSS versions)

The automatic water/detergent dosing system was designed with extreme durability and reliability in mind. If, however, the supply pump does not work, the appliance can function even when the system is not operational. To bypass the supply pump, it is necessary to:

1. Take the appliance to its dedicated maintenance area.
2. Take all necessary steps to ensure that the device is in a safe condition (see "[MACHINE SAFETY](#)").



ATTENTION: users are advised to always wear protective gloves, to avoid the risk of serious injury to hands.

3. Grip the handle (1) on the rear left side of the recovery tank and turn the recovery tank until it reaches the work position.
4. Secure the recovery tank with the hinge (2).
5. Turn the tap's lever (3) to bypass the supply pump.

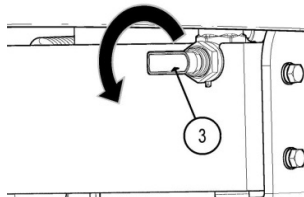
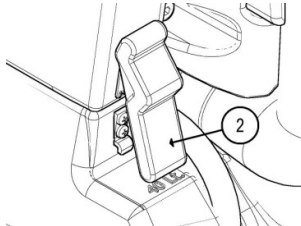
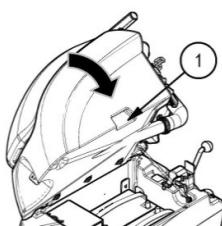

ATTENTION: Placing the tap lever in this way, the FSS dosing system is excluded and the detergent solution will be expelled and fall on the brushes. Reduce the water system flow to zero, turn the relevant knob (1) to the right (work direction). Reduce the detergent flow in the water system to zero, turn the relevant knob to the right (work direction).



ATTENTION: Reading the paragraph "[REGULATING THE DETERGENT \(only for systems without FSS\)](#)" is recommended.

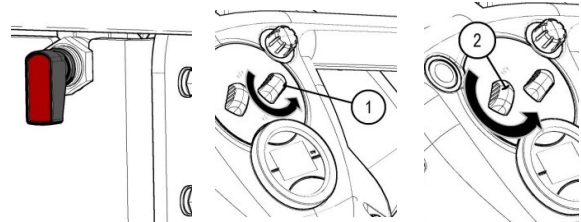

ATTENTION: Placing the tap lever in this way there will be no leakage of detergent solution on the brushes. Reduce the water flow in the water system to zero, turn the relevant knob to the right (work direction). Reduce the detergent flow in the water system to zero, turn the relevant knob to the right (work direction).

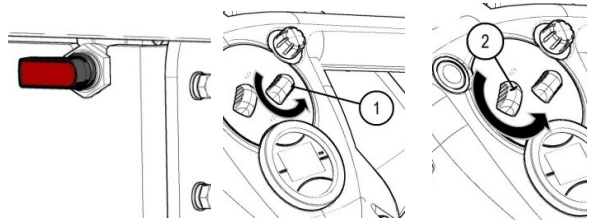

ATTENTION: By positioning the tap lever in this way, the DS dosing system is activated.

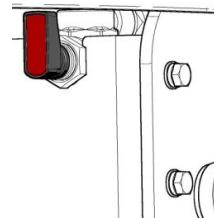

DISPOSAL

Proceed with scrapping the machine in accordance with the waste disposal regulations in force in the country in which the machine is being used.



CHOOSING AND USING BRUSHES

POLYPROPYLENE BRUSH (PPL)

Used on all types of floors. Good resistance to wear and tear, and hot water (no greater than 50°C). PPL is non-hygroscopic and therefore retains its characteristics even when working in wet conditions.

NYLON BRUSH

Used on all types of floors. Excellent resistance to wear and tear, and hot water (even over 50°C). The nylon is hygroscopic and so tends to lose its characteristics over time when working in wet conditions.

ABRASIVE BRUSH

The bristles of this type of brush are charged with highly aggressive abrasives. It is used to clean very dirty floors. To avoid floor damage, work only with the pressure strictly necessary.

STEEL BRUSH

The bristles are in steel wire. It is used to descale floors that are abrasion-resistant, very irregular or with wide joints.

BRISTLE THICKNESS

Thicker bristles are more rigid and are therefore used on smooth floors or floors with small joints.

On uneven floors or those with deep joints, it is advisable to use softer bristles which can enter the gaps more easily.

Remember that when the bristles are worn and therefore too short, they will become rigid and are no longer able to penetrate and clean deep down. In this case, like with over-large bristles, the brush tends to jump.

PAD HOLDER

The pad holder is recommended for cleaning shiny surfaces.

There are two types of pad holder:

1. The traditional pad holder is fitted with a series of anchor points that allow the abrasive floor pad to be held and dragged while working.
2. The CENTRE LOCK type pad holder not only has anchor points, but also a snap-type central locking system in plastic that allows the abrasive floor pad to be perfectly centred and held without any risk of it becoming detached. This type of pad holder is recommended above all for machines with more than one brush, where the centring of the abrasive discs is difficult.

TABLE FOR CHOOSING THE BRUSHES

Appliance	No. Br.	Code	Type of bristles	Ø Bristles	Ø Br.	Notes
MMx 43	1	414309	PPL	0.3	420	Blue brush
		414310	PPL	0.6		White brush
		414311	PPL	0.9		Black brush
		414312	ABRASIVE	1		
	405507	-	-	420	Pad holder with center lock	
MMx 50	1	404654	PPL	0.3	508	Blue brush
		405631	PPL	0.6		White brush
		404653	PPL	0.9		Black brush
		405632	ABRASIVE	1		
	405527	-	-	500	Pad holder with center lock	
MMx 52	2	405601	PPL	0.3	255	Blue brush
		405604	PPL	0.6		White brush
		405602	PPL	0.9		Black brush
		405603	ABRASIVE	1		
	405513	-	-	255	Pad holder with center lock	

EC DECLARATION OF CONFORMITY

The undersigned manufacturer:

FIMAP S.p.A.
Via Invalidi del Lavoro, 1
37059 Santa Maria di Zevio (VR)

declares under its sole responsibility that the products:

FLOOR SCRUBBING MACHINE mod. MMx43 B – MMx50 B – MMx52 B

comply with the provisions of Directives:

- 2006/42/EC: Machinery Directive.
- 2014/30/EU: Electromagnetic compatibility directive.

They also comply with the following standards:

- EN 60335-1:2012/A11:2014
- EN 60335-2-72:2012
- EN 12100:2010
- EN 61000-6-2:2005/AC:2005
- EN 61000-6-3:2007/A1:2011/AC:2012
- EN 62233:2008/AC:2008

The person authorized to compile the technical file:

Mr. Giancarlo Ruffo
Via Invalidi del Lavoro, 1
37050 Santa Maria di Zevio (VR) - ITALY

Santa Maria di Zevio, 18/09/2019

FIMAP S.p.A.
Legal representative
Giancarlo Ruffo

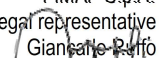

FIMAP spa
Via Invalidi del Lavoro, 1 - 37059 S.Maria di Zevio (Verona) Italy
Tel. +39 045 6060411 r.a. - Fax +39 045 6060417 - Email: fimap@fimap.com - www.fimap.com

EC DECLARATION OF CONFORMITY

The undersigned manufacturer:

FIMAP S.p.A.
Via Invalidi del Lavoro, 1
37050 Santa Maria di Zevio (VR)

declares under its sole responsibility that the products

FLOOR SCRUBBING MACHINE mod. MMx43 B CB – MMx50 B CB – MMx52 B CB

comply with the provisions of Directives:

- 2006/42/EC: Machinery Directive.
- 2014/35/EU: Low Voltage Directive.
- 2014/30/EU: Electromagnetic compatibility directive.

They also comply with the following standards:

- EN 60335-1:2012/A11:2014
- EN 60335-2-72:2012
- EN 12100:2010
- EN 60335-2-29:2004/A2:2010
- EN 61000-6-2:2005/AC:2005
- EN 61000-6-3:2007/A1:2011/AC:2012
- EN 61000-3-2:2014
- EN 61000-3-3:2013
- EN 55014-1:2006/A1:2009/A2:2011
- EN 55014-2:2015
- EN 62233:2008/AC:2008

The person authorized to compile the technical file:

Mr. Giancarlo Ruffo
Via Invalidi del Lavoro, 1
37050 Santa Maria di Zevio (VR) - ITALY

Santa Maria di Zevio, 18/09/2019

FIMAP S.p.A.
Legal representative
Giancarlo Ruffo

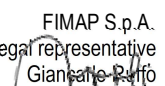

FIMAP spa
Via Invalidi del Lavoro, 1 - 37050 S.Maria di Zevio (Verona) Italy
Tel. +39 045 6060411 r.a. - Fax +39 045 6060417 - Email: fimap@fimap.com - www.fimap.com



FIMAP - Via Invalidi del Lavoro, 1 - 37059 S. Maria di Zevio - Verona - Italy
Tel. +39 045 6060411 - Fax +39 045 6060417 - E-mail: fimap@fimap.com
www.fimap.com