

MXL



POWER IN AN EXTRA LARGE SIZE

 **FIMAP®**

MxL



The scrubbing machine that changes the user experience from the very first glance

The shape of the machine inspires a sense of safety and control, thanks to the harmonious and balanced design that promises a user experience that is out of the ordinary. MxL has the power you need to work in any environment and under the most difficult conditions, as a result of its careful design, which combines high-performance components with the most advanced technology.

As soon as you turn it on, you can feel the value of a machine created to enhance the professional results of every cleaning operation, with innovative features that provide operators with all the tools necessary to successfully complete their work.





MXL

Its robust design is not afraid of any environment

The wrap-around lines delineate an enveloping structure made from polyethylene, which protects the heart of the machine and enhances its robust appearance.

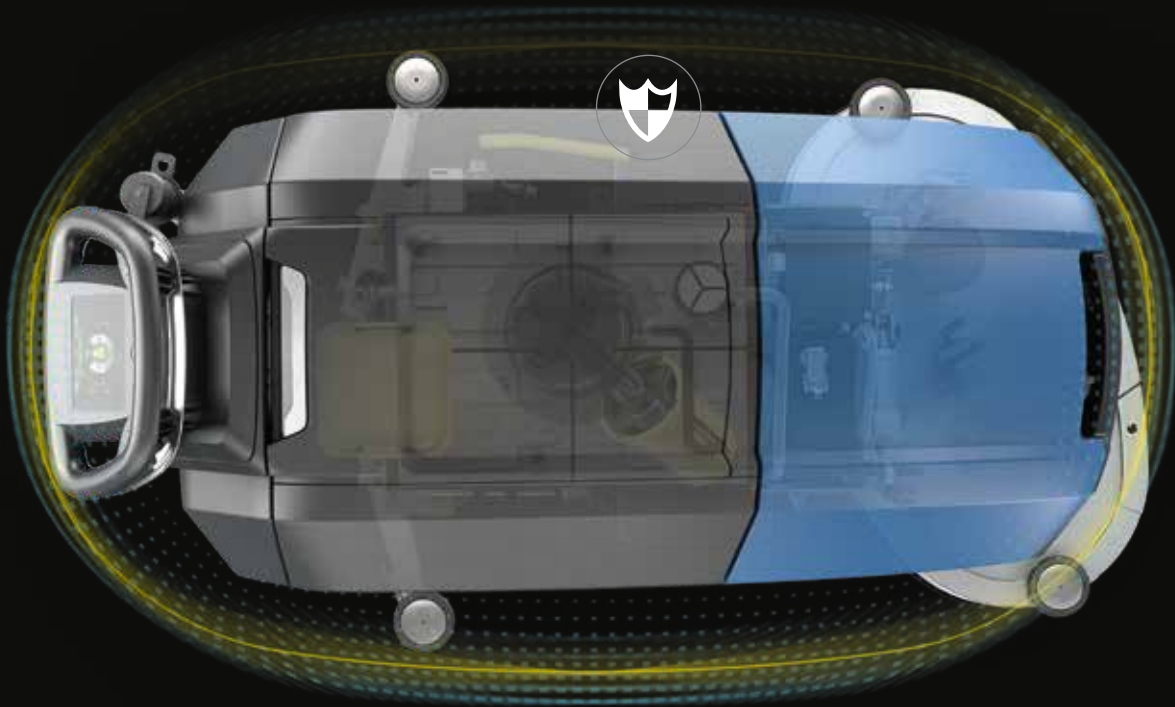

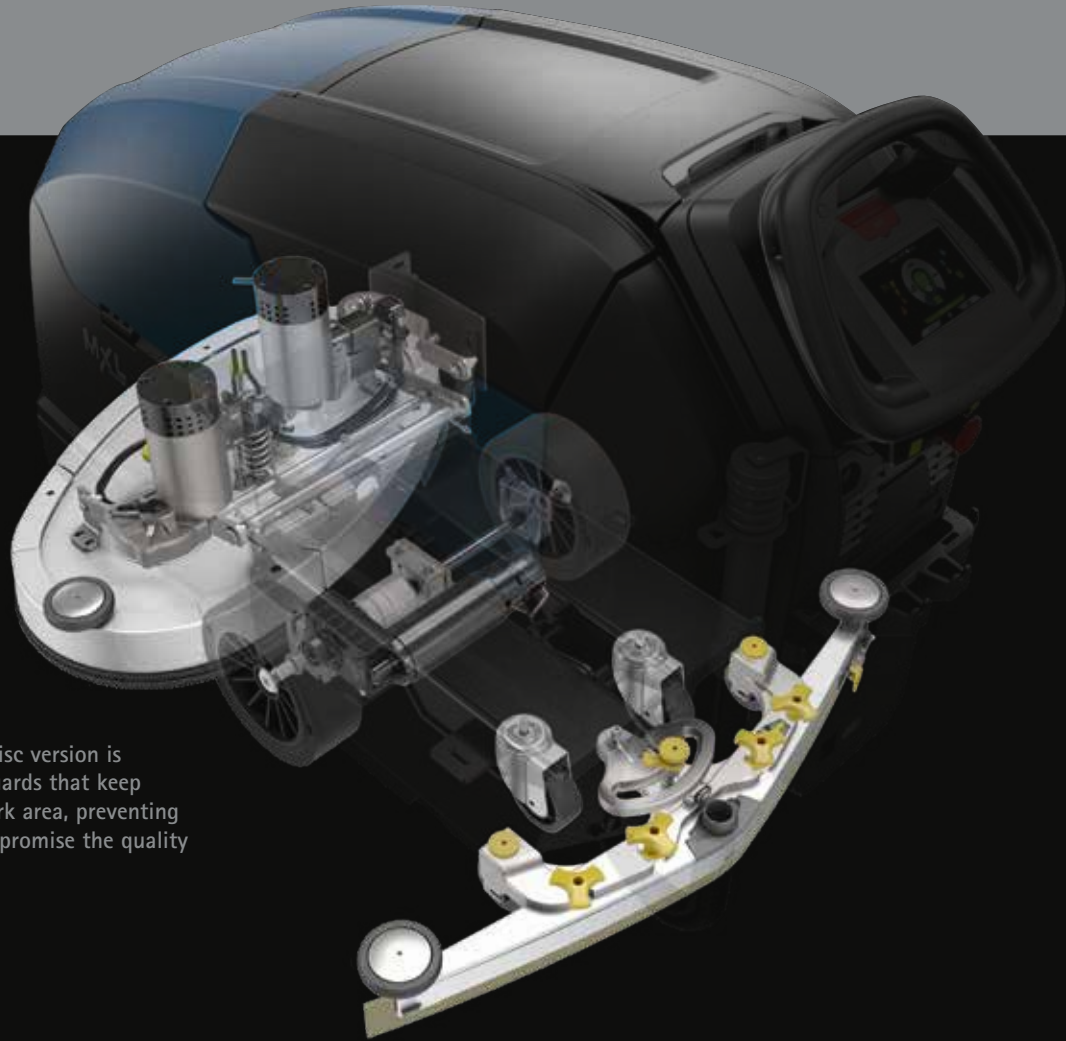

The brush head of the disc version is equipped with splash guards that keep the water inside the work area, preventing splashes that could compromise the quality of the end result.

The brush head and the squeegee are made from aluminum, a material chosen for its durability and reliability over time as well as for its lightness, to provide you with better manoeuvrability and comfort.

MxL

MxL gives more value to your time: it reduces downtimes and increases productivity



QUIET OPERATIONS

With the Eco Mode and FNC technologies that lower the noise level, MxL safeguards the health of the operator and that of the people in the environment where it is used.

 **EASY MAINTENANCE – COLOR CODED PARTS**
Parts which must be cleaned at the end of every shift are color coded in yellow. Regular maintenance of these parts ensures the correct operation of the machine, along with consistent performance.



FFF – FIMAP FAST FILL
Automatic system for filling the fresh water tank, lets the operator perform other activities while the tank quickly fills up.



ACCESSORY STORAGE COMPARTMENT

The operator can work in absolute tranquility in the knowledge that when he needs them, all the accessories are close at hand, and once finished with, these can easily be placed back in their compartment, allowing the cleaning operation to proceed without long interruptions and wasted time.



NO TRAINING

No doubt will keep you from your work. The integrated video tutorials on the display demonstrate how to perform routine and extraordinary maintenance, to prevent uncertainty and wasted time.



The spray gun has a dual role. During machine maintenance, it facilitates the rinsing of the tanks at the end of the shift, but it can also be used during the work, to moisten stubborn dirt stains and make them easier to remove.



Powerful and versatile, it is always ready to meet your goals



POWER MODE

When performing localized heavy duty cleaning, pressing the Power mode function activates a work mode that uses all the scrubbing parameters to the maximum, for a short period of time. This enables the machine to act with greater force on a specific area just for the time needed, without wasting resources and having to resort to passing over the area more than once.

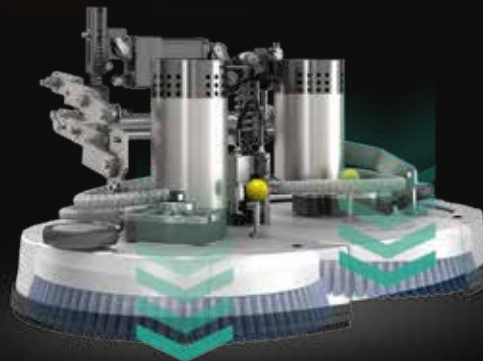



Consistent cleaning results

Pressure on the brushes is kept constant, delivering consistent high cleaning results on any type of flooring.



No risk of slipping

The powerful 3-stage vacuum motor leaves the floor immediately dry and safe.



VACUUM WAND

Vacuum wand allows to clean areas that are out of reach of the machine and successfully fulfill the task.



FLR-FIMAP LONG RANGE
Increases productivity by up to 70%.

Great autonomy
Work for up to 5 hours non-stop.

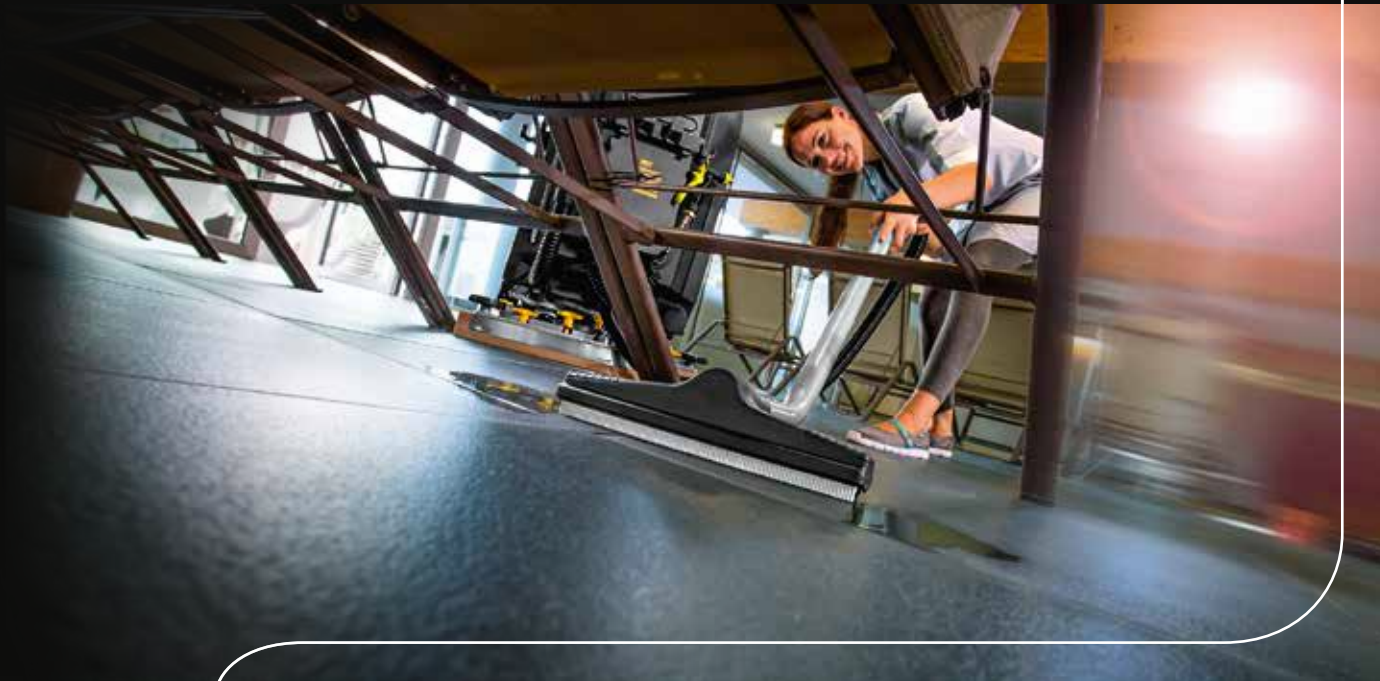



Equipped to give you safety and protection

The equipment on the MxL prevents accidents, increases safety while working and supports the operator at all times, so that everything is always under control, without ever encountering difficulties.

ACTIVE TECHNOLOGIES to prevent accidents



Enhances visibility in dim light.



TOUCH SCREEN DISPLAY

For a fast operator training and reduced cost to clean.



VIDEO TUTORIALS

Control device letting the operator set the required speed.



CRUISE CONTROL

Maximize work safety in all conditions.



LED HEADLIGHTS

Automatically operated when the machine stops. It works as a safety parking brake.



ELECTROBRAKE



 **SOS MxL**

PASSIVE SYSTEMS to help the operator in case of emergency



SOS DEVICE

Reduces time to service in case of emergency. The red button sends an SMS alert to receive prompt help, reducing downtimes.



EMERGENCY STOP

By pressing a single button the machine stops immediately.

MXL



iD—intelligent Drive



TOUCH SCREEN
DISPLAY



LOG-IN WITH
PASSWORD



ZONE PROGRAMS



CRUISE
CONTROL



SUSTAINABLE
CLEANING



SEVERE
CLEANING



VIDEO
TUTORIALS

You will feel like you have always known how to use it

The color interface is so user-friendly that it needs no explanation, just a glance is all it takes to have everything under control. Through the touch screen, you can explore all the solutions of the iD – intelligent Drive system, which will make every operation unique.



LOG-IN WITH PASSWORD
To protect your investment



ZONE PROGRAMS
For all the performance you'll ever need



ECO MODE
To protect the environment



POWER MODE
For maximum power when you need it



VIDEO TUTORIALS
For a more efficient, fast and easy operator training



EXPERIENCE CONNECTIVITY

Discover the FFM universe and experience the advantages of being constantly connected, with My.Machine app!





Watch the video



FIMAP FLEET MANAGEMENT

My.Machine app updates you in real time providing all the essential information to help you keep high the fleet performance. You can see from your smartphone or tablet where your machines are, if they're carrying out the cleaning task or

if any anomaly occurred. You can see the list of the services performed, the charger logs and anomalies occurred, in order to have a complete overview of the health status of each machine.

Keep tabs on your machines remotely when you want and from wherever you want!



GEOLOCATION

It shows on a map the machine.



USE INFORMATION

It's possible to know in what working mode the machine is operating and for how long. Moreover, it provides information about the duration of each intervention and the sq.m cleaned.



HEALTH STATUS

Anytime is possible to monitor the health condition of both machines and batteries to have a clear view of the fleet availability and optimize its coordination.



ENVIRONMENTAL IMPACT

All the data related to the CO₂ produced per intervention are available as well as the water and detergent consumption, in order to take action and improve the performance.



ALARMS

The anomalies occurred are summarized in a list which includes a description of the type of issue, and the date and time of the event. It helps you to have an overview of the improper uses that need to be corrected.



BATTERY RECHARGE

It sums up all the complete and opportune recharges performed, the residual charge and the charge settings. This is an essential set of information to extend the battery lifespan and reduce the related costs.



SERVICES

An overview of the list of the maintenance services performed allows to identify discrepancies with the health condition of the machine in case an anomaly is detected, and to monitor the inspections of the whole fleet.



Protect the environment with efficient management of resources

With better management of resources, you can clean more sq.m with the same levels of consumption, avoiding waste. Fimap technologies optimize the use of water, detergent and energy to protect the environment and reduce the cost of cleaning per sq.m.



The Eco Mode function helps prevent water, detergent and energy consumption by using only the quantities you need and nothing more.



START&STOP

When the machine is idle, the brush motor, the vacuum motor*, the traction and the water flow will turn off automatically, reducing costs and emissions. All the functions are reactivated automatically when the operator presence control is operated.

* In basic and Pro versions suction turns off when the squeegee is lifted up

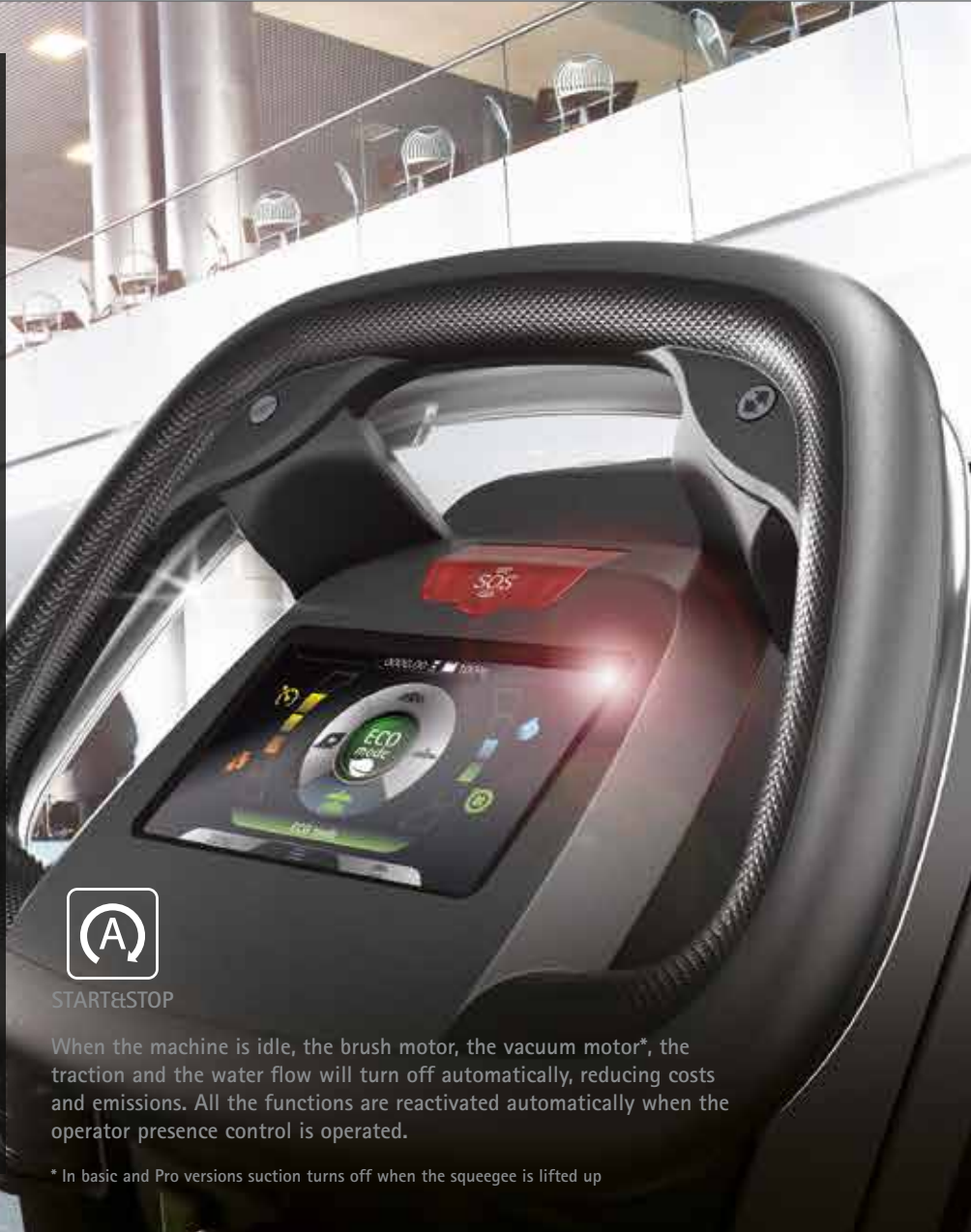



WATER



FLR-FIMAP LONG RANGE

Reduces water and detergent consumption per cleaning operation by up to 66%*
This is a system which recycles detergent solution to increase autonomy:
to scrub more sq.m. while using less resources.



FSS-FIMAP SOLUTION SAVER

Water and detergent quantities are separately dosed,
reducing consumption by up to 50%.



FWF-FIMAP WATER FLOW

Ensures uniform cleaning results across the entire working
width on the first pass, optimizing detergent solution consumption.

ENERGY



FES-FIMAP ENERGY SAVER

Reduces energy consumption by up to 35%.

LED TECHNOLOGY

Up to 80% lower energy consumption than conventional headlights.
The LED headlights consume much less energy than conventional headlights, offer a
longer lifespan and illuminate with a brilliant white light similar to natural daylight.



NOISE LEVELS



FNC-FIMAP NOISE CANCELLING

Reduces sound pressure.

*Saving calculated on a triple recycling cycle



Make it perfect for you:
configure it with the characteristics
that are ideal for your needs

Choose your machine



DISC
with 2 disc brushes
or 2 pad holders.



CYLINDRICAL
with 2 cylindrical brushes
and a debris hopper
for small sized solid debris.

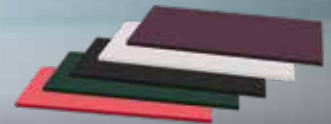

ORBITAL
with pad



LIGHT

MEDIUM

HEAVY



MxL DISC

The brush head with disc brushes is the most versatile option, as this can adapt to all types of hard floors, both smooth and irregular, in any environment. The force of the two brushes easily removes even stubborn dirt.

MxL CYLINDRICAL

The brush head with cylindrical brushes combines the scrubbing action with a sweeping action, which reduces the operation time when it comes to cleaning floors on which small solid residues are present, avoiding the need to sweep before scrubbing. The residues are collected in a drawer installed at the rear of the brush head, which is removable for emptying.



MxL ORBITAL

With the orbital movement, every point of the pad is in constant contact with the floor, ensuring that the cleaning result is always uniform across the entire surface, with reduced energy consumption. The pad action traps the solution and stops it running off at the sides, thereby reducing water consumption.





With flexible equipment options, you can configure it in the most convenient and beneficial way for you

Choose the instrument panel



Basic

PRO

PLUS

Membrane
control panel



Touch screen
display

OPTIONALS



Vacuum wand



Spray gun



FFF – FIMAP FAST FILL



FFM-FIMAP FLEET MANAGEMENT



Front driving LED headlights



FSS-FIMAP SOLUTION SAVER



Battery charger on board

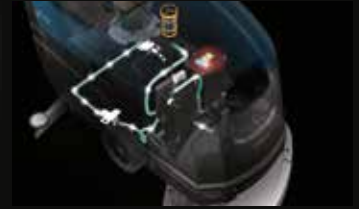

FLR-FIMAP LONG RANGE



Antibacterial tanks help inhibit the growth of bacteria and mold

ACCESSORIES

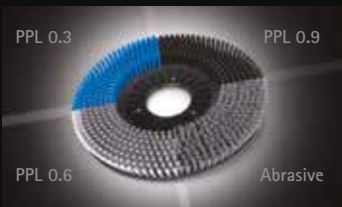

A wide choice of disc or cylindrical brushes in PPL is offered, available in thicknesses from 0.3 to 0.9 cm. These offer the perfect solution for dealing with any type of dirt on any floor.
Abrasive brushes: Ideal for heavy duty cleaning on industrial surfaces.

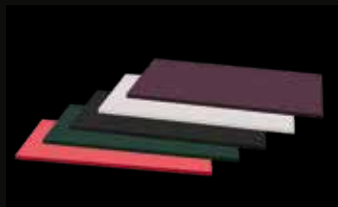

Pads
BLACK – Hard pad for heavy duty cleaning of resistant floors with stubborn dirt
GREEN – Medium-hard pad for maintenance and heavy duty cleaning of resistant floors
RED – Medium-soft pad for daily maintenance of any type of flooring
WHITE – Soft pad for finishing wax/oiled surfaces and fine polishing
BROWN – Heavy duty pad for wet and dry scraping



Rear squeegee rubber blades
33 SHORE (PARA) For maintenance cleaning of smooth floors.
40 SHORE (PARA) For stubborn dirt on floors with joints.
POLYURETHANE For heavy duty cleaning on industrial floors, even with wide gaps.



Squeegee holder accessory



E-Spray holder hooks

OPTIONAL AND STANDARD EQUIPMENT

USER EXPERIENCE	DUAL DISC									CYLINDRICAL			ORBITAL
	65 Bt	65 Bt Pro	65 Bt Plus	75 Bt	75 Bt Pro	75 Bt Plus	85 Bt	85 Bt Pro	85 Bt Plus	70 Bts	70 Bts Pro	70 Bts Plus	70 Bto Plus
iD-Intelligent Drive:	-	-	•	-	-	•	-	-	•	-	-	•	•
- 5 inch high resolution colour touch screen	-	-	•	-	-	•	-	-	•	-	-	•	•
- Log-in with password	-	-	•	-	-	•	-	-	•	-	-	•	•
- Zone programs	-	•	•	-	•	•	-	•	•	-	•	•	•
- Cruise control	-	•	•	-	•	•	-	•	•	-	•	•	•
- Eco Mode	•	•	•	•	•	•	•	•	•	•	•	•	•
- Power Mode	-	-	•	-	-	•	-	-	•	-	-	•	•
- Video tutorials	-	-	•	-	-	•	-	-	•	-	-	•	•
Membrane control panel	-	•	-	-	•	-	-	•	-	-	•	-	-
COMFORT													
Hour meter	•	•	•	•	•	•	•	•	•	•	•	•	•
Cleaning solution level indicator	•	•	•	•	•	•	•	•	•	•	•	•	•
Fresh water empty tank light	-	-	•	-	-	•	-	-	•	-	-	•	•
Battery charger	○	○	○	○	○	○	○	○	○	○	○	○	○
Brush and squeegee actuator	-	-	•	-	-	•	-	-	•	-	-	•	•
Brush head actuator	-	•	-	-	•	-	-	•	-	-	•	-	-
Brush head manual lifting	•	-	-	•	-	-	•	-	-	•	-	-	-
Squeegee manual lifting	•	•	-	•	•	-	•	•	-	•	•	-	-
Vacuum wand with 3-stage motor*	-	○	○	-	○	○	-	○	○	-	○	○	○
Spray gun*	-	○	○	-	○	○	-	○	○	-	○	○	○
Squeegee holder accessory	○	○	○	○	○	○	○	○	○	○	○	○	○
E-Spray holder hooks	○	○	○	○	○	○	○	○	○	○	○	○	○
FFF (Fimap Fast Fill)	-	○	○	-	○	○	-	○	○	-	○	○	○
Noiseless suction	-	•	-	-	•	-	-	•	-	-	•	-	-
PRODUCTIVITY													
Water flow selector	-	•	•	-	•	•	-	•	•	-	•	•	•
Triple pressure selector	-	-	•	-	-	•	-	-	•	-	-	•	•
Double pressure	-	•	-	-	•	-	-	•	-	-	•	-	-
FFM (Fimap Fleet Management) with SOS device	○	○	○	○	○	○	○	○	○	○	○	○	○
Squeegee and squeegee support in aluminum	•	•	•	•	•	•	•	•	•	•	•	•	•
Vacuum speed selector	-	-	•	-	-	•	-	-	•	-	-	•	•
SAFETY													
Driving LED headlights (front)	○	○	•	○	○	•	○	○	•	○	○	•	•
Emergency Stop	•	•	•	•	•	•	•	•	•	•	•	•	•
Electro parking brake	•	•	•	•	•	•	•	•	•	•	•	•	•
Antibacterial tanks	○	○	○	○	○	○	○	○	○	○	○	○	○
ENVIRONMENT													
FSS (Fimap Solution Saver)**	-	○	○	-	○	○	-	○	○	-	○	○	○
FLR (Fimap Long Range)**	-	○	○	-	○	○	-	○	○	-	○	○	○
FNC (Fimap Noise Canceling)	•	-	-	•	-	-	•	-	-	•	-	-	-
FES (Fimap Energy Saver)	•	•	•	•	•	•	•	•	•	•	•	•	•
FWF (Fimap Water Flow)	•	•	•	•	•	•	•	•	•	-	-	-	-
Start&Stop	•	•	•	•	•	•	•	•	•	•	•	•	•

* In PRO versions the two devices cannot be installed together

** The two devices cannot be installed together

• STANDARD

○ UPON REQUEST

- NOT AVAILABLE

DIMENSIONS AND TECHNICAL DATA

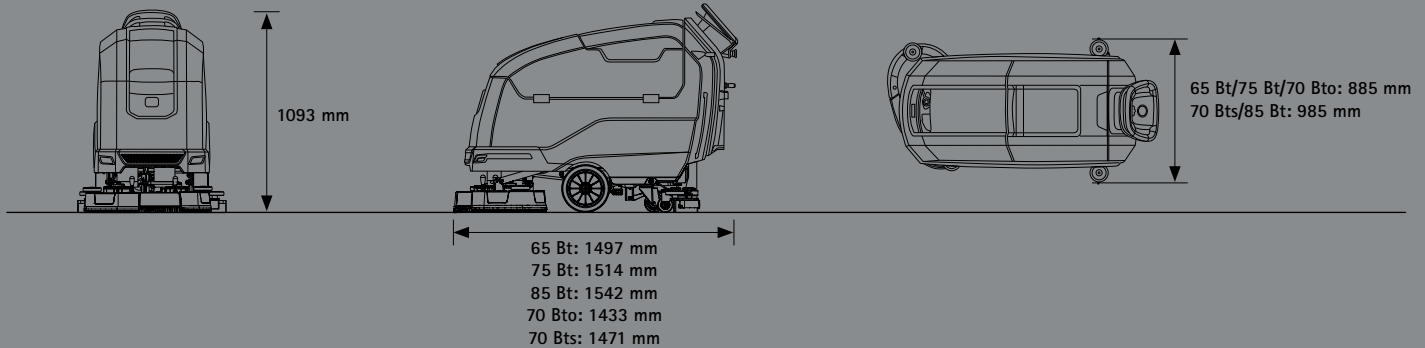

TECHNICAL DATA - MxL	DUAL DISC									CYLINDRICAL			ORBITAL		
	65 Bt	65 Bt Pro	65 Bt Plus	75 Bt	75 Bt Pro	75 Bt Plus	85 Bt	85 Bt Pro	85 Bt Plus	70 Bts	70 Bts Pro	70 Bts Plus	70 Bto Plus		
Productivity theoretical	up to sqm/h		2620			3000			3400			2580			
Estimated coverage	up to sqm/h		1638			1913			2100			1613			1780
SCRUBBING SYSTEM															
Working width	mm	655			765			840			645			710	
Brushes motors	(no.) V/W				(2) 24/500						(2) 24/450			(1) 24/680	
Brushes rpm	rpm				140						550			-	
Oscillations	rpm							-						2000	
Pressure on the brushes (min. - med. - max)	kg	33	33÷55	33÷45÷55	35	35÷57	35÷45÷57	38	38÷60	38÷45÷60	33	15÷40	15÷30÷40	40÷50÷60	
TANKS AND RECOVERY SYSTEM															
Solution tank	l							80							
Recovery tank	l							85							
Suction motor	V/W							24/422							
Vacuum water lift	mbar							112							
3-stage vacuum motor (for vacuum wand)	V/W	-	24/680		-	24/680		-	24/680		-	24/680			
Vacuum water lift (3-stage motor)	mbar	-	166		-	166		-	166		-	166			
Detergent tank capacity (FSS)	l							3							
Maximum volume of the debris hopper	l							-			8			-	
BATTERIES															
Supply/traction	V							24/aut.							
Batteries	(no.) V/Ah C5							(4) 6/180 GEL							
Battery run time*	up to h	5	4,4		5	4,4		5	4,4		4,5		5		
PROPELLING SYSTEM															
Forward working speed	km/h							4							
Transport speed	km/h							4,9							
Traction motor	V/W							(1) 24/300						(1) 24/520	
SPECIFICATIONS															
Machine dimensions (l x h x w)	mm	1497			1514			1542			1471			1433	
		1093			1093			1093			1093			1093	
		701			795			878			733			734	
Squeegee width	mm	885			885			985			985			885	
Machine weight empty without batteries	kg	186	191		188	193		191	196		187	192		195	
Machine weight empty with batteries	kg	310	315		312	317		315	320		311	316		319	
GVW (Gross Vehicle Weight)	kg	387	400		389	402		392	405		388	410			
Sound level (ISO 11201)	dB (A)							<70						64,8	

* Run times are based on continuous scrubbing run times

SERVICES

CONSULTING AND PLANNING



We put our experience at your service, to help you realize the cleaning project perfect you. We suggest you the best solutions to make costs decrease and service quality increase.

SETUP



We can help you set up your machines in order to make them meet specifically the requirements of the sites of your project, allowing you to always have control over costs and results.

AUTHORIZED WORKSHOP NETWORK



Fimap Authorized Workshop network spans the globe, so you can enjoy the peace of mind of finding a professional support wherever your business is.

CONFIGURATION



Your business is unique, only a customized fleet can lead you to better results. We will help you find the configurations that best fit the specific requirements of your cleaning sites, in order to optimize processes and lower costs.

TRAINING COURSES



Fimap Academy offers courses for all levels, from the correct use of machines and technologies, up to the management of sites and tenders, helping you to make your service really competitive.

MAINTENANCE AND REPAIR



For your business to run smoothly it is essential that your machines are kept always operational. Our technicians take care of monitoring the machines health status and know how to intervene quickly and effectively when needed.

FINANCIAL SOLUTIONS



You can choose to use the fleet in different ways. We can advise you on the best financial solution for your business, so that you can get the quality of the Fimap world at the most convenient conditions for you.

DIGITAL FLEET MANAGEMENT SYSTEM



With Fimap Fleet Management everything is under your control. You can have a complete overview of the service provided and find out the improvements that can be made, basing your considerations on real data, always available via the MyMachine app or FFM website.

GENUINE SPARE PARTS



Get the most out of your machines, choose the reliability of Fimap original spare parts. They are designed together with the machines, so they perfectly fit them thus guaranteeing the highest quality of performance.

CERTIFICATIONS



For any additional information or for a demo please contact your usual Fimap dealer



FIMAP spa - Via Invalidi del Lavoro, 1 - 37059 S. Maria di Zevio - Verona - Italy
Tel. +39 045 6060411 - Fax +39 045 6060417 - E-mail: fimap@fimap.com

