

FIMOP

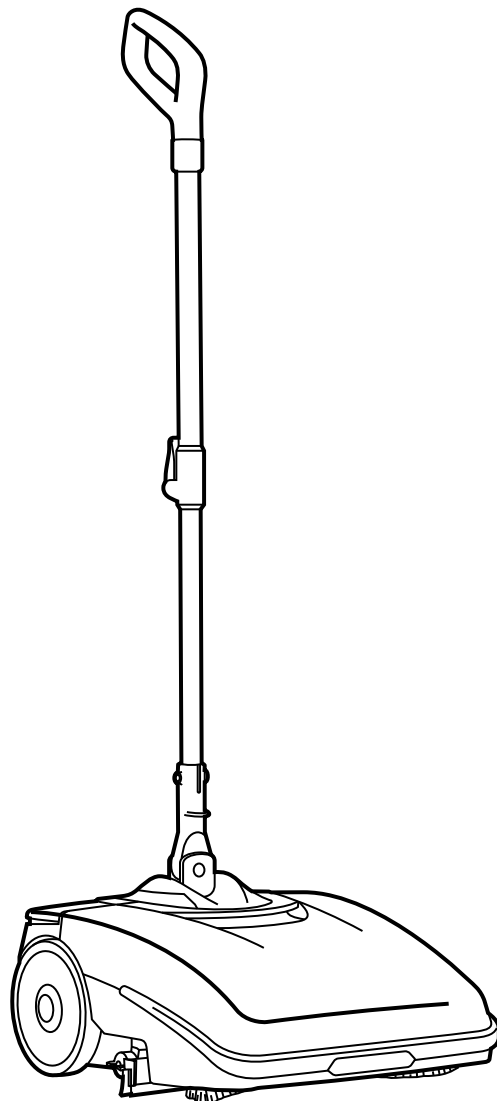

COMMERCIAL AUTOSCRUBBER

USE AND MAINTENANCE MANUAL

 **FIMAP**[®]



ORIGINAL INSTRUCTION DOC. 10053541 - Ver. AC - 10-2019

CONTENTS

CONTENTS	3
GENERAL SAFETY REGULATIONS	3
RECHARGING THE BATTERIES.....	4
USING THE MACHINE.....	4
DEACTIVATION OF THE MACHINE.....	6
MAINTENANCE.....	6
TRANSPORT.....	7
DISPOSAL.....	7
SYMBOLS USED IN THE MANUAL	8
SYMBOLS USED ON THE MACHINE	8
PURPOSE AND CONTENT OF THE MANUAL	8
TARGET GROUP	8
PRESERVATION OF THE USER	8
ON CONSIGNMENT OF THE MACHINE	8
INTRODUCTORY COMMENT	8
IDENTIFICATION DATA	8
TECHNICAL DESCRIPTION	8
TECHNICAL DESCRIPTION	8
SAFETY	8
SERIAL NUMBER PLATE	8
SPARE PARTS	9
HANDLING THE PACKAGED MACHINE	9
HOW TO UNPACK THE MACHINE	9
HOW TO MOVE THE MACHINE	9
BATTERY TYPE	9
RECHARGING THE BATTERY	9
PREPARATION OF MACHINE	10
PREPARING TO WORK	10
WORK	11
AT THE END OF THE WORK	11
MAINTENANCE	12
TROUBLESHOOTING	13
DISPOSAL	14
EC DECLARATION OF CONFORMITY	14

GENERAL SAFETY REGULATIONS

The following symbols are used to indicate any potentially hazardous situations. Always read this information carefully and take the necessary precautions to protect any people and/or objects that may be present.

Operator cooperation is paramount for accident prevention. No accident prevention programme can be effective without the full cooperation of the person directly responsible for the machine's operation. Most accidents that occur at the workplace, during work activities, or while in transit, are caused by the failure to respect the most basic safety regulations. An attentive, careful operator is most effective guarantee against accidents and is fundamental in order to implement any prevention programme.



DANGER: Indicates an imminent danger that could cause serious injury or death.



WARNING: Indicates a probable dangerous situation that could cause serious injury or death.



CAUTION: Indicates a probable dangerous situation that could cause minor injuries.



ATTENTION: Indicates a probable dangerous situation that could damage objects.



N.B.: Indicates a note regarding essential or useful functions.



CONSULTATION: Indicates the need to consult the Operator's Manual before performing any operation.

RECHARGING THE BATTERIES



DANGER:

- If the battery charger power cable is damaged or broken, it should be replaced by the manufacturer, by authorised service personnel or else by a qualified person, in order to protect against hazards.
- Keep sparks, flames, and incandescent materials at a safe distance from the batteries.
- Before charging check that the electric cable that connects the battery charger to the batteries is not damaged, and if it is damaged do not use it and contact technical assistance.
- Before using the battery charger, check that the electric socket that connects the battery charger to the mains is not damaged, and if it is do not use it and contact an authorised service technician or another qualified person, in order to avoid and hazardous situations.
- Do not disconnect the battery charger cable from the machine socket when the battery charger is operating. This is necessary to prevent electric arcs forming. To disconnect the battery charger when charging, first disconnect the power cable from the mains socket.



WARNING:

- Do not use incompatible battery chargers since they could damage the batteries and potentially cause a fire. To charge the battery only use the detachable power pack provided with this machine.
- Keep the battery charger's cable at a safe distance from any hot surfaces.
- Carefully read the user manual of the battery charger you want to use before recharging.
- Do not disconnect the battery charger from the mains socket with wet hands.

USING THE MACHINE



DANGER:

- In the event of danger, quickly press the machine's main switch and remove the battery from the battery compartment.
- Never collect gases, explosive/inflammable liquids or powders, nor acids and solvents! These include gasoline, paint thinners and fuel oil (which, when mixed with the vacuum air, can form explosive vapours or mixtures), and also non-diluted acids and solvents, acetones, aluminium and magnesium powders. These substances may also corrode the materials used to construct the machine.
- If the machine is used in dangerous areas (e.g. petrol stations), the relative safety standards must be observed. It is forbidden to use the machine in environments with a potentially explosive atmosphere.



WARNING:

- The machine must be exclusively used by authorised, trained personnel.
- Do not use the machine on surfaces with a slope greater than the one indicated on the serial number plate.
- The machine is not suitable for cleaning rough or uneven floors. Do not use the machine on slopes.

- In the event of a fire, use a powder extinguisher. Do not use water.
- Adapt the speed to the adhesion conditions.
- In order to prevent the unauthorised use of the machine, the power supply must be interrupted, switch the machine off using the main switch, remove the battery from the battery compartment.
- Do not use the machine without the requisite knowledge and authorisations.
- Do not use the machine if you have not read and understood the following user manual.
- Do not use the machine under the influence of alcohol or drugs.
- Do not use the machine when using a mobile phone or other types of electronic devices.
- Do not use the machine if it is not working correctly.
- Do not use the machine in areas where there are inflammable vapours or liquids or combustible powders.
- Do not use the machine in areas that are too dark to see the controls or operate the machine safely, unless the work lights or the front headlights are on.

**CAUTION:**

- This machine must not be used by people (including children) with reduced physical, sensorial and mental capabilities, or by people without any experience or knowledge, unless they have been controlled and instructed in the use of the machine by those responsible for their safety. Children must be supervised to ensure they do not play with the machine.
- During the working of the machine, pay attention to other people and especially to children.
- The machine must only be powered with a voltage equal to that shown on the serial number plate.
- Read the labels on the machine carefully. Do not cover them for any reason, and replace them immediately if they become damaged.
- The machine must only be used and stored in an enclosed or covered environment.
- The machine must not be used or stored outdoors in damp conditions or directly exposed to rain.
- The machine does not cause harmful vibrations.
- Use the machine only in the way described in this manual.
- Do not pick up anything that is burning or smouldering, like cigarettes, matches or glowing embers.
- Always follow the instructions for mixing, use and disposal on the containers of the chemical substances.

**ATTENTION:**

- Always take appropriate measures to protect any individuals and/or objects that may be present while using this machine.
- Be careful to avoid collisions with shelving or scaffolding, above all if there is a risk of objects falling from heights.
- Do not place any liquid containers on the machine.
- The machine must only be used under temperature conditions ranging from 0 °C to +40 °C.
- When using detergents to clean the flooring, always follow the instructions and respect the warnings indicated on the containers' labels.
- Always use appropriate gloves and protective equipment when handling the detergents used to clean the floor.
- Avoid working with the brushes when the machine is standing still, so as to avoid damage to the floor.

- Do not allow any objects to penetrate into the machine's openings. Do not use the machine if the openings are obstructed.
- Keep the machine's openings free of any dust, lint, hairs, or any other foreign materials that could reduce the airflow.
- Do not remove or alter any labels affixed to the machine.
- Use only the brush supplied with the machine or those specified in the following manual. Using other brushes compromises the safety of the machine and its operator.
- Before starting to work check that there are no leaks.
- Before starting to work check that all the safety devices have been installed and are working correctly.
- Take all due precautions so that hair, jewellery, loose clothing do not get entangled in the machine's moving parts.
- Only use the machine in well-lit areas.



The machine must not be transported or parked in its rest position when the solution tank and recovery tank are full.

DEACTIVATION OF THE MACHINE



WARNING:

- Always protect the machine against sunlight, rain, and other atmospheric agents, both while it is stationary and while it is in function. Store the machine in a dry, sheltered place: this machine is only designed for use under dry conditions, and must not be used or stored outdoors under humid conditions.
- Do not park the machine near combustible materials, powders, gases or liquids.
- Stop the machine on a flat surface.
- Switch off the machine and remove the battery from the battery compartment.
- If the machine is left unattended, it must be protected from any accidental movements



CAUTION:

- In order to prevent the unauthorised use of the machine, the power supply must be interrupted, switch the machine off using the main switch, remove the battery from the battery compartment.



ATTENTION:

- The machine must only be stored under temperature conditions ranging from 0 °C to +40 °C. The humidity level must be between 30% and 95%.

MAINTENANCE



DANGER:

- In order to avoid short-circuits when working in the vicinity of electrical components, do the following: avoid the use of non-insulated tools; do not place or allow metallic objects to fall upon the electrically powered components; remove any rings, watches and/or clothing with metallic parts that might come into contact with the electrically powered components.

 **WARNING:**

- Read all the relevant instructions carefully before performing any maintenance/repair operations.
- If the machine does not work properly, check this is not caused by failure to carry out routine maintenance. Otherwise, ask for intervention of the authorised technical assistance centre.
- Restore all electrical connections after any maintenance interventions.

 **CAUTION:**

- For any maintenance work, switch the machine off using the main switch, remove the battery from the battery compartment.
- Avoid contact with moving parts. Do not wear loose clothing or jewellery and tie long hair back.

 **ATTENTION:**

- Never tamper with the machine's protection devices for any reason; always follow the supplied routine maintenance instructions scrupulously.
- If any issues are encountered while using the machine, check to make sure that these are not due to a lack of proper maintenance. Otherwise, request the intervention of authorized personnel or an Authorized service centre.
- When replacing parts, ask for ORIGINAL spare parts from a Dealer or an authorised retailer.
- In order to ensure the machine is safe to use and operates properly, carry out the maintenance work specified in this manual.
- Do not clean the machine with direct or pressurized jets of water, or with corrosive substances.
- Have the machine checked by an authorised technical assistance centre every year.
- When disposing of consumable materials, observe the laws and regulations in force. Once the machine has reached the end of its service life, the materials contained within it must be disposed of in an appropriate manner, keeping in mind that the machine itself has been built using fully recyclable materials.
- All repairs must be carried out by qualified personnel.
- Do not physically change the design characteristics of the machine.
- Use spare parts provided by authorised service centres.
- Wear personal protective equipment as required and as suggested in the manual.

TRANSPORT

 **WARNING:**

- **Drain both tanks before transport.**
- Move the squeegee to the rest position.
- Remove the battery from the battery compartment.

DISPOSAL

 **ATTENTION:**

- The machine should not be abandoned at the end of its working life because of the presence of toxic-harmful substances in it, which are subject to regulations that regulate their disposal in special centres.

The descriptions contained in this document are not binding. The company therefore reserves the right to make any modifications at any time to elements, details, or accessory supply, as considered necessary for reasons of improvement or manufacturing/commercial requirements. The reproduction, even partial, of the text and drawings contained in this document is prohibited by law.

The company reserves the right to make any technical and/or supply modifications. The images are for reference purposes only, and are not binding in terms of design and supply.

SYMBOLS USED IN THE MANUAL

- Open book symbol with an "i"**
Indicates the need to consult the instruction manual.

- Open book symbol**
Tells the operator to read the user manual before using the device.

- Covered place symbol:**
The operations preceded by this symbol must always be carried out in a dry, covered area.

- Warning symbol:**
Carefully read the sections preceded by this symbol meticulously following the instructions indicated for the safety of the operator and the device.

- Protective gloves symbol:**
Always wear protective gloves, to avoid the risk of serious injury to your hands.

- Tool symbol:**
Indicates the need to use tools not included in the supply.

- Explosion risk symbol:**
Indicates that the battery may explode in certain conditions, if not handled in accordance with the directives indicated in the manufacturer's manual.

- Disposal symbol:**
Carefully read the sections marked with this symbol for disposing of the appliance.

- Recycling symbol:**
Tells the operator to carry out the operations in compliance with environmental regulations in force in the place where the appliance is being used.

- Tank drainage symbol:**
Informs the operator that the recovery tank must be emptied every time the solution tank is filled.

- Recycling symbol:**
Carefully read the sections marked with this symbol in order to fill the solution tank correctly.

SYMBOLS USED ON THE MACHINE

- Main switch symbol:**
Used on the central rear of the machine to indicate the main switch.

- Solenoid valve switch symbol:**
Used on the rear of the machine to indicate the solenoid valve control switch.

- Symbol for squeegee movement to "work position":**
Indicates the rotation direction of the squeegee control knob in order to bring the squeegee rubbers into contact with the floor.

- Symbol for squeegee movement to "idle position":**
Indicates the rotation direction of the squeegee control knob in order to raise the squeegee rubbers off the floor.

- Lifting point symbol:**
Used to indicate the location of the elements for lifting the machine or else moving the mobile parts of the machine.

- "OPEN" symbol:**
Used on the upper part of the appliance to indicate the position of the handle for opening the front carter.

- Warning symbol not to rotate the machine:**
indicates that the machine must not be rotated when the tanks are full.

PURPOSE AND CONTENT OF THE MANUAL

The aim of this manual is to provide customers with all the information needed to use the machine in the safest, most appropriate and most autonomous way. This includes information concerning technical aspects, safety, operation, downtime, maintenance, spare parts and scrapping. The operators and qualified technicians must carefully read the instructions in this manual before carrying out any operations on the machine. If in doubt about the correct interpretation of instructions, contact your nearest Customer Service Centre to obtain the necessary clarifications.

TARGET GROUP

This manual is written both for operators and for qualified machine maintenance technicians. Operators must not perform operations that should be carried out by qualified technicians. The manufacturer is not liable for damages resulting from failure to comply with this prohibition.

PRESERVATION OF THE USER

The following document must be stored in its special pouch close to the machine, protected from liquids and anything else that could compromise its legibility.

ON CONSIGNMENT OF THE MACHINE

When the machine is consigned to the customer, an immediate check must be performed to ensure all the material mentioned in the shipping documents has been received, and also to check the machine has not suffered damage during transportation. If this is the case, the carrier must ascertain the extent of the damage at once, informing our customer service office. It is only by prompt action of this type that the missing material can be obtained, and compensation for damage successfully claimed.

INTRODUCTORY COMMENT

Any machine can only work properly and effectively if used correctly and kept in full working order by carrying out the maintenance operations described in the attached documentation. We therefore suggest you read this instruction booklet carefully and read it again whenever difficulties arise while using the machine. If necessary, remember that our assistance service (organised in collaboration with our dealers) is always available for advice or direct intervention.

IDENTIFICATION DATA

For technical assistance or to request replacement parts, always give the model, the version and the serial number (written on the relevant plate).

TECHNICAL DESCRIPTION

The **FIMOP** is a floor scrubbing machine that cleans a wide range of flooring and dirt types by means of the mechanical action of a cylindrical brush and the chemical action of a water-detergent solution, collecting the dirt as it moves forward that has been removed and the detergent solution that has not been absorbed by the floor. **The machine must only be used for this purpose.**

TECHNICAL DESCRIPTION

This machine was designed and built for the cleaning (scrubbing and drying) of smooth, compact flooring in the commercial, residential and industrial sectors by a qualified operator in proven safety conditions. The machine is not suitable for cleaning rugs or carpets. The machine is only suitable for use in closed (or at least covered) places.

WARNING: The machine is not suitable for use in the rain, or under jets of water.

IT IS FORBIDDEN to use the machine for picking up dangerous dusts or inflammable liquids in places with an explosive atmosphere. In addition, it is not suitable as a means of transport for people or objects.

SAFETY

Operator cooperation is paramount for accident prevention. No accident prevention programme can be effective without the full cooperation of the person directly responsible for machine operation. The majority of occupational accidents that happen either in the workplace or whilst moving are caused by failure to respect the most basic safety rules. An attentive, careful operator is most effective guarantee against accidents and is fundamental in order to implement any prevention programme.

SERIAL NUMBER PLATE

The serial number plate is located in the power supply battery compartment on the rear part of the machine, indicating its general characteristics, and in particular the serial number. The serial number is a very important piece of information and should always be provided together with any request for assistance or when purchasing spare parts.

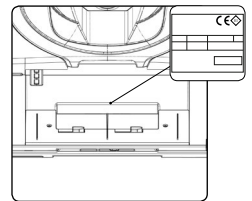

TECHNICAL DATA	U/M	FIMOP
Total power	W	150
Working width	mm	340
Working capacity, up to	m ² /h	680
Central brush (number / (diameter x length))	No. / (Ømm x mm)	1 / (110 x 340)
Brush motor (rated)	V/W	24 / 50
Suction motor (rated)	V/W	24 / 100
Maximum gradient	%	2
Solution tank capacity	l	1.2
Recovery tank capacity	l	1
Machine body length	mm	430
Machine body height	mm	215
Overall dimensions in standby position (L x h x w)	mm	395 x 1295 x 445
Overall dimensions in idle position (L x h x w)	mm	395 x 915 x 365
Rated battery voltage	V / mAh	25.55 / 5200
Battery weight	kg	1
Machine weight when empty (machine + brush + squeegee)	kg	9
Machine weight in transport (machine + battery + brush + squeegee)	kg	10
Machine weight ready to use (machine + battery + detergent solution + brush + squeegee)	kg	11.4
Sound pressure level (ISO 11201) - L _{pa}	dB (A)	<70
Uncertainty K _{pa}	dB (A)	1.5
Hand vibration level (ISO 5349)	m/s ²	< 2.5
Vibration measurement uncertainty		4%

SPARE PARTS

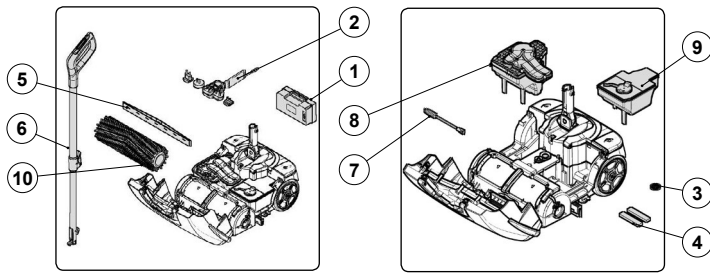

POS.	CODE	QTY	DESCRIPTION
1	440974	1	BATTERY
2	441033	1	BATTERY CHARGER
3	439888	1	DETERGENT SOLUTION FILTER
4	441025	2	ANTI-DUST FILTER
5	224800	1	SQUEEGEE RUBBER KIT
6	224615	1	CONTROL HANDLEBAR
7	441023	1	TUBE-CLEANING BRUSH
8	227332	1	RECOVERY TANK
9	224619	1	SOLUTION TANK
10	440905	1	SOFT BRUSH
	440904	1	HARD BRUSH

HANDLING THE PACKAGED MACHINE

The machine is contained in specific packaging, and since the packaging elements (plastic bags, staples, etc.) are a potential source of danger, they should not be left within the reach of children, disabled persons, etc. The machine's overall weight including packaging is 18 Kg. The packaging dimensions are as follows:

	U/M	FIMOP
A	mm	270
B	mm	487
C	mm	698

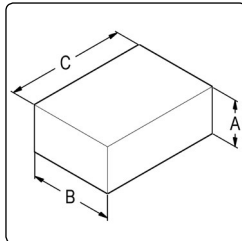

HOW TO UNPACK THE MACHINE

The procedure for unpacking the machine is as follows:

- Place the lower part of the outer packaging in contact with the floor.

CAUTION: Use the pictograms printed on the box as reference.

- Open the outer box.
- Remove the accessories from the box and carefully lay them on the ground.
- Take the machine out of the box.

ATTENTION: it is recommended that all the packaging components be kept for any future machine transportation.

CAUTION: these operations must be carried out using protective gloves to avoid any possible contact with the edges or tips of metal objects.

HOW TO MOVE THE MACHINE

The procedure for the safe transportation of the machine is the following:

- If the machine is running, switch it off by pressing the main switch (1) (Fig.1).
- Make sure the recovery tank is empty. If it isn't, empty it completely.
- Make sure the solution tank is empty. If it isn't, empty it completely.
- Remove the battery (2) from the battery compartment; to free the battery, shift the stop lever (3) in the direction of the arrow (Fig.2). Remove the battery from the machine using the handle moulded on it (Fig.3).

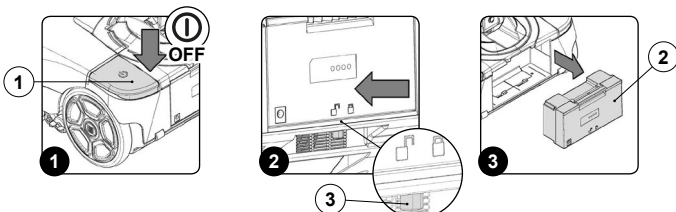

- Block the handlebar in the horizontal position. Rest your foot on the body of the machine to prevent it from tilting, then push the handle away from you until it snaps into the horizontal position (Fig.4).

CAUTION: do not rest your foot on the main switch.

- Rotate the stop lever of the command handlebar (4) in the direction of the arrow (Fig.5).
- Close the command handlebar, pushing the handle (5) towards the body of the machine (Fig.6).

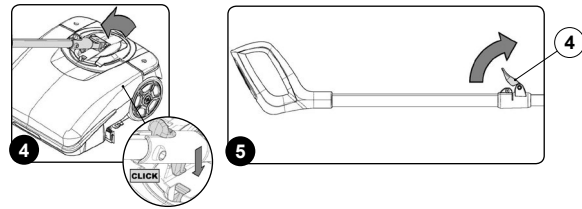

- Rotate the stop lever of the command handlebar (4) in the direction of the arrow (Fig.7).
- To lift the machine off the floor, use the handle (6) on its rear (Fig.8).

CAUTION: When transporting on vehicles, secure it firmly in place in compliance with the directives in force so that it cannot slide or tip over.

CAUTION: these operations must be carried out using protective gloves to avoid any possible contact with the edges or tips of metal objects.

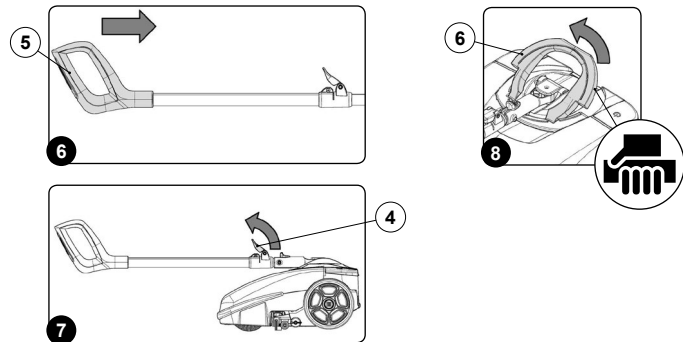

The machine must not be transported or parked in its rest position when the solution tank and recovery tank are full.

BATTERY TYPE

To power the appliance, use only the battery supplied in the packaging or one supplied by a specialised technician. **OTHER BATTERY TYPES CANNOT BE USED.** The machine is powered by a lithium-ion battery. The battery compartment can accommodate a single battery slot at 25.55V.

WARNING: for the maintenance and disposal of the battery, refer to the document supplied by the battery manufacturer.

RECHARGING THE BATTERY

The battery must be charged prior to the first use, and when it doesn't provide enough power for tasks that could formerly be performed without difficulty. To recharge the battery, proceed as follows:

- Take the machine to the designated place for charging the battery.

WARNING: the place for charging the battery should be suitably ventilated.

- If the machine is running, switch it off by pressing the main switch (1) (Fig.1).
- Block the handlebar in the vertical position.

CAUTION: during this operation, do not rest your foot on the machine.

- Read the battery charger manual that comes with the machine for inserting the power plug (2) into the power pack (3) (Fig.2).

CAUTION: before connecting the battery charger to the socket, make sure the characteristics of the mains supply correspond to those of the battery charger.

WARNING: the battery charger must only be used in a covered place.

- Connect the power plug (2) to the mains supply.

WARNING: make sure the green LED (4) on the battery charger lights up when you enable the battery charger base circuit (Fig.3). This LED indicates that the battery charger circuit is correctly powered.

- Remove the cap (5) covering the battery power socket (Fig.4).

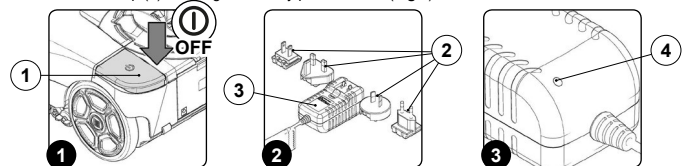

- Insert the battery charger power cable plug (6) in the socket (7) on the battery (Fig.5).

WARNING: make sure the green LED (4) on the battery charger lights up when you enable the charger (Fig.3). This LED indicates that the battery charger circuit is correctly powered.

CAUTION: before inserting the plug (6) in the socket (7), make sure the battery charger housing compartment is not dirty (dust, condensation or other types of liquid).

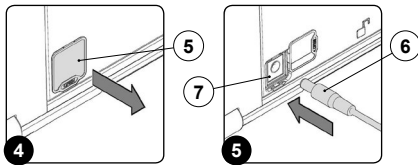

CAUTION: make sure the red LED (4) on the battery charger lights up when you insert the plug (6) in the socket (7). This LED indicates that the battery is recharging.

8. Perform a complete battery charging cycle.

ATTENTION: the red LED (4) remains on until the battery is fully charged. When the recharging cycle has ended, the red LED goes off and the green LED comes on.

ATTENTION: The charger and the battery can be left connected to the power outlet. The red LED (4) lights up when the charger occasionally tops up the battery.

ATTENTION: the red charge status LED (4) does not provide any indication of the battery charge level.

ATTENTION: during the charging phase, the battery may overheat. This is normal and does not mean there is any problem with the battery.

ATTENTION: if the battery used in this machine is over-charged, this may cause a risk of fire, explosion or chemical burns.

9. Once the charging cycle is completed, remove the plug (2) on the battery charger from the mains socket.

ATTENTION: To prevent damaging to the mains socket, disconnect the plug from the mains socket by directly pulling the plug and not the power cable.

10. Take the power cable plug (6) out of the socket (7) on the battery.
11. Insert the cap (5) that covers the battery power socket.

PREPARATION OF MACHINE

1. Take the package to the dedicated maintenance area.
2. Remove the machine and all the accessories from the box.
3. Insert the lower tube (1) of the control handlebar in the hole on the joint (2) (Fig.1).
4. Fix the handlebar to the joint using the screw and nut (3), making sure the hole on the handlebar coincides with the hole on the joint (Fig.2).

N.B.: the screwdriver is not supplied.

5. Block the handlebar in the horizontal position. Rest your foot on the body of the machine to prevent it from tilting, then push the handle away from you until it snaps into the horizontal position (Fig.3).

CAUTION: do not rest your foot on the main switch.

6. Rotate the stop lever of the handlebar (4) in the direction of the arrow (Fig.4).
7. Close the command handlebar again, pushing the handle (5) towards the body of the machine (Fig.5).

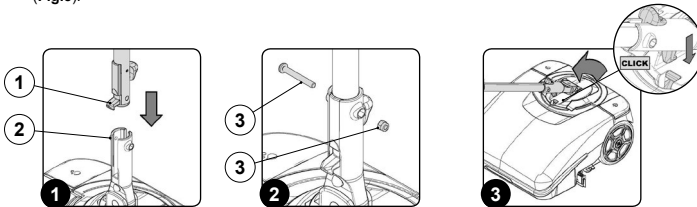

8. Rotate the stop lever of the handlebar (4) in the direction of the arrow (Fig.6).
9. Insert the battery (6) in the battery compartment (7) in the rear of the machine (Fig.7). Push the battery until the uncoupling lever (8) locks into place.

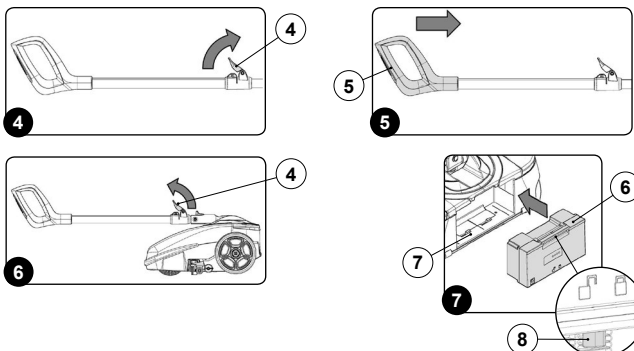

PREPARING TO WORK

Before beginning to work, it is necessary to:

N.B.: before beginning the first work cycle, fully recharge the battery (read "RECHARGING THE BATTERY").

1. Before using the machine, make sure it is in a good, safe working condition. If everything is not in order, the machine must not be used.
2. Rotate the handlebar so it is vertical.

CAUTION: During this operation, do not rest your foot on the machine.

3. Start the machine using the main switch (1) (Fig.1).

N.B.: If the LED of the main switch (1) (Fig.1) is lit up, this means there is electrical continuity.

4. Check the battery charge level. There are four LEDs (2) on the battery to show the charge percentage (Fig.2). If all the LEDs are lit up, the battery is fully charged; if they are all switched off, the battery is completely run down.
5. Switch off the machine using the main switch (1) (Fig.3).
6. Remove the battery (3) from the battery compartment; to free the battery, shift the stop lever (4) in

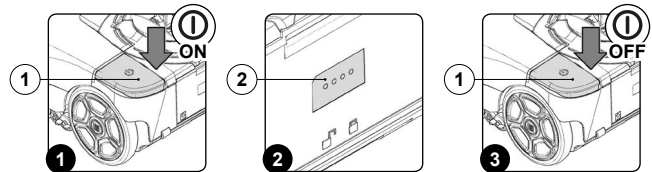

the direction of the arrow (Fig.4).

7. Remove the battery from the battery compartment using the handle moulded on it (Fig.5).
8. Make sure the condition of the squeegee rubbers is suitable for the work you want to carry out. If it isn't, perform the necessary maintenance (read "MAINTENANCE").
9. Make sure the condition of the brush is suitable for the work you want to carry out. If it isn't, perform the necessary maintenance (read "MAINTENANCE").
10. Rotate the front carter (5) as far as it will go - do this with the aid of the handle (6) (Fig.6).

CAUTION: these operations must be carried out using protective gloves to avoid any possible contact with the edges or tips of metal objects.

11. Remove the solution tank from the machine (Fig.7). Carefully place it on the floor.

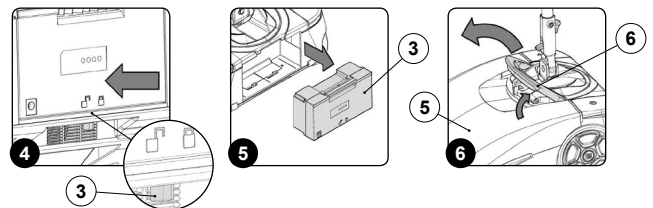

12. Remove the detergent solution filling cap (7) from its seat on the solution tank (Fig.8).
13. Fill with clean water, at a temperature no higher than 50°C and no lower than 10°C.
14. Add the liquid detergent to the solution tank in the concentration and manner indicated on the detergent manufacturer's label.

N.B.: The formation of excess foam could damage the vacuum motor, so use only the minimum amount of detergent that is necessary.

N.B.: always use detergents whose manufacturer's label indicates their suitability for scrubbing machines. Do not use acid or alkaline products or solvents without this indication. Acid or alkaline maintenance detergents can be used, as long as they have pH values between four and ten, and do not contain : oxidising agents, chlorine or bromine, formaldehyde, mineral solvents.

CAUTION: protective gloves should always be worn before handling detergents or acidic or alkaline solutions, to avoid serious injury to the hands.

N.B.: always use low-foam detergent. To avoid the production of foam, put a minimum quantity of anti-foam liquid in the recovery tank before starting to clean. Do not use pure acids.

15. Replace the detergent solution filling cap (7) in its seat on the solution tank (Fig.9).

N.B.: it is good practice to empty the recovery tank every time you top up the solution tank level.

16. Insert the solution tank in the machine (Fig.10).
17. Rotate the front carter (5) as far as the work position - do this with the aid of the handle (6) (Fig.11).
18. Insert the battery in the battery compartment in the rear of the machine.

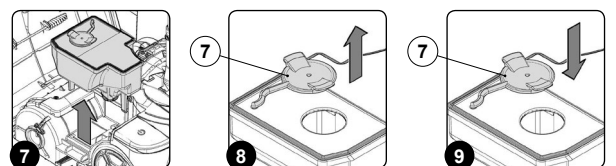

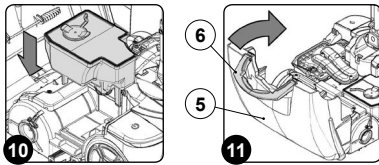

WORK

Before beginning to work, it is necessary to:

1. Carry out the operations described in the "PREPARING TO WORK" chapter.
2. Check that the squeegee body is in contact with the surface to be cleaned. If it isn't, turn the knob (1) in the direction of the arrow (Fig.1).

i **N.B.:** Fig.1 shows the left side of the device. Rotate the knob on the right-hand side in the opposite direction.

3. Release the handlebar from its vertical position and rotate it towards you.

! **CAUTION:** During this operation, do not rest your foot on the machine.

4. Adjust the control handlebar.
5. Start the machine using the main switch (2) (Fig.2).

i **N.B.:** if the LED of the main switch (2) (Fig.2) is lit up, this means there is electrical continuity.

i **N.B.:** As soon as the machine starts, the front LEDs will light up and both the brush motor and the suction motor will start working.

6. Activate the detergent solution supply by pressing the electric pump control switch (3) (Fig.3).

i **N.B.:** if the LED of the electric pump control switch (3) (Fig.3) is active, this means the pump will supply detergent solution.

7. The machine will now begin to work with full efficiency until the battery runs down or until the detergent solution has finished.

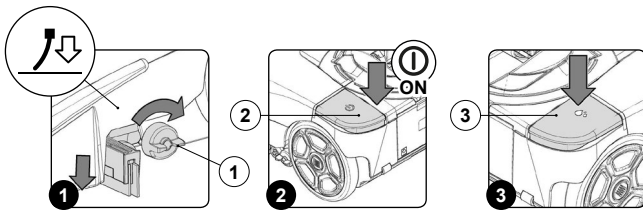

i **N.B.:** The joint on the body of the machine provides greater manageability. To make a left-hand turn, rotate the handle to the left (Fig.4); rotate it to the right when you want to turn right.

i **N.B.:** If you need to turn back while you are working, just rotate the machine by 180° by turning the control handle.

i **N.B.:** if the handlebar is placed in the idle position (vertical) during use, the brush motor and electric pump will stop working. After a few seconds, the suction motor will switch off as well.

i **N.B.:** if the charge level reaches a certain value during use, the brush motor and the electric pump will stop working. After a few seconds, the suction motor will switch off automatically as well. Both the LED of the main switch and that of the electric pump control switch will remain ON.

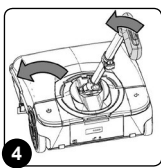

AT THE END OF THE WORK

At the end of the work, and before carrying out any type of maintenance, perform the following operations:

1. Switch off the machine using the main switch (1) (Fig.1).
2. Rotate the handlebar so it is vertical.

! **CAUTION:** During this operation, do not rest your foot on the machine.

3. Raise the squeegee body off the floor and rotate the knob (2) in the direction of the arrow (Fig.2).

i **N.B.:** Fig.2 shows the left side of the machine. Rotate the knob on the right-hand side in the opposite direction.

4. Take the appliance to the dedicated dirty water drainage area.

! **ATTENTION:** the place designated for this operation must comply with current environmental protection regulations.

5. Remove the battery (3) from the battery compartment; to free the battery, shift the stop lever (4) in the direction of the arrow (Fig.3).

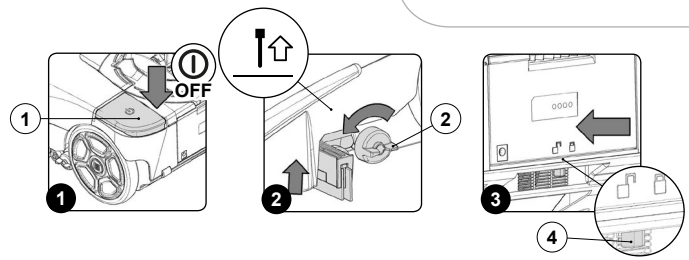

6. Remove the battery from the battery compartment using the handle moulded on it (Fig.4).
7. Rotate the front carter (5) as far as it will go - do this with the aid of the handle (6) (Fig.5).

! **CAUTION:** these operations must be carried out using protective gloves to avoid any possible contact with the edges or tips of metal objects.

8. Remove the recovery tank (7) from the machine (Fig.6).
9. Remove the drain plug (8) on the recovery tank from its seat (Fig.7).

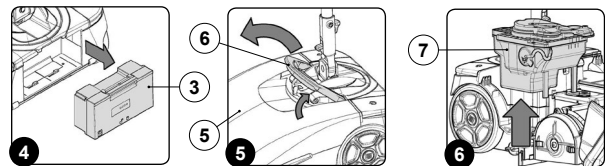

! **ATTENTION:** protective gloves should always be worn before handling detergents or acidic or alkaline solutions, to avoid serious injury to the hands.

10. Empty the tank.
11. Insert the solution drain plug (8) into its seat on the solution tank (Fig.8).
12. Remove the solution tank from the machine (Fig.9).
13. Remove the filling cap (9) from its seat on the detergent solution tank (Fig.10).
14. Empty the tank.

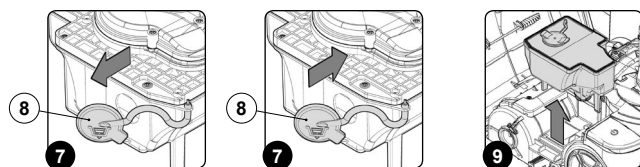

15. Rinse the inside of the tank with a jet of water.
16. Replace the filling cap (9) in its seat on the detergent solution tank (Fig.11).
17. Insert the two tanks in the machine, positioning first the solution tank and then the recovery tank.
18. Rotate the front carter (5) as far as the work position; do this with the aid of the handle (6) (Fig.12).
19. Block the handlebar in the horizontal position (Fig.13).

! **CAUTION:** During this operation, do not rest your foot on the machine.

20. Turn the stop lever of the command handlebar (10) in the direction of the arrow (Fig.14).

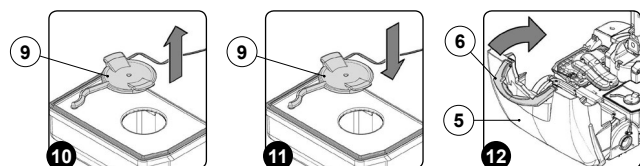

21. Close the command handlebar again, pushing the handle (11) towards the body of the machine (Fig.15).
22. Turn the stop lever of the command handlebar (10) in the direction of the arrow (Fig.16).
23. Take the machine to the designated machine storage place.
24. Position the machine with its rear part in contact with the floor (Fig.17).

! **WARNING:** Park the machine in an enclosed place, on a flat surface; near the machine there must be no objects that could either damage it, or be damaged through contact with it.

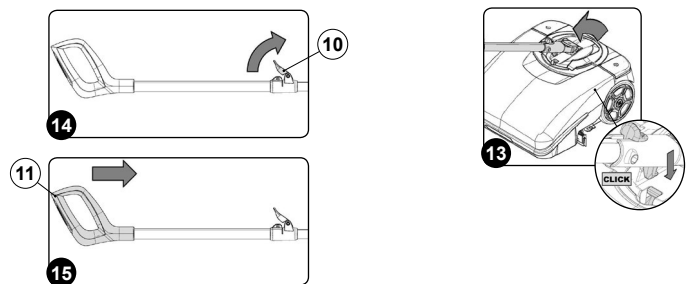

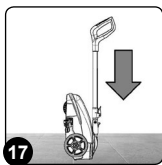
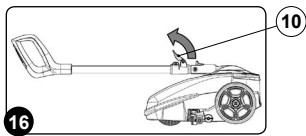

MAINTENANCE

At the end of the work, and before carrying out any type of maintenance, perform the following operations:

1. Switch off the machine using the main switch (1) (Fig.1).
2. Rotate the handlebar so it is vertical.

CAUTION: During this operation, do not rest your foot on the machine.

3. Take the machine to the designated maintenance area.

N.B.: the place designated for this operation must comply with current environmental protection regulations.

4. Remove the battery (2) from the battery compartment; to free the battery, shift the stop lever (3) in the direction of the arrow (Fig.2).

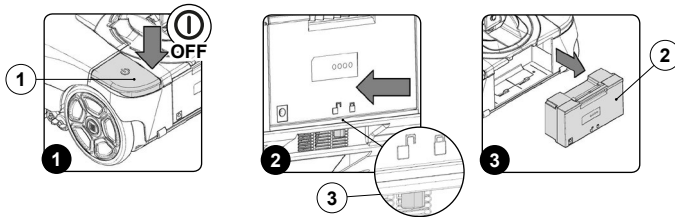

5. Remove the battery from the battery compartment using the handle moulded on it (Fig.3).
6. Rotate the front carter (4) as far as it will go - do this with the aid of the handle (5) (Fig.4).

CAUTION: these operations must be carried out using protective gloves to avoid any possible contact with the edges or tips of metal objects.

7. Remove the tunnel cover (6) and shift the stop levers (7) as indicated by the arrows (Fig.5).
8. Remove the brush (8) from the machine (Fig.6).

ATTENTION: During this operation, keep the control handlebar still, in order to prevent the machine from moving accidentally.

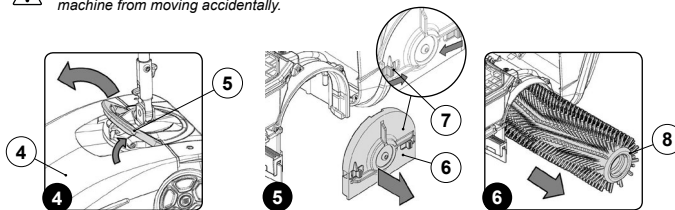

9. Clean the brush under running water and remove any impurities present in the bristles of the brush. Check that the bristles are not worn; in the event of excessive wear, replace the brush (the bristles should be at least 10 mm long).
10. Fit the brush (8) on the pin in the brush motor (the brush can only be inserted in one direction) (Fig.7).
11. Replace the tunnel cover (6) and shift the stop levers (7) as indicated by the arrows (Fig.8)
12. Remove the recovery tank (9) from the machine (Fig.9).

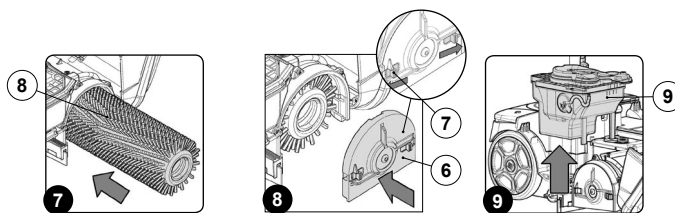

13. Remove the drain plug (10) on the recovery tank from its seat (Fig.10).

ATTENTION: protective gloves should always be worn before handling detergents or acidic or alkaline solutions, to avoid serious injury to the hands.

14. Clean with a jet of air the suction motor air channel chamber, the chamber inlet hole is marked with the letter (A) (Fig.11).
15. Clean with a jet of air the dirty water channel chamber, the chamber inlet hole is marked with the letter (B) (Fig.12).

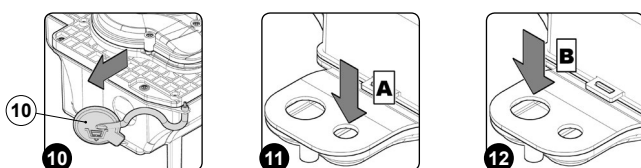

16. Rinse the inside of the tank with a jet of water.
17. Insert the drain cap (10) in its seat on the detergent solution tank (Fig.13).
18. Remove the solution tank from the machine (Fig.14).
19. Remove the filling cap (11) from its seat on the solution tank (Fig.15).
20. Rinse the inside of the tank with a jet of water.

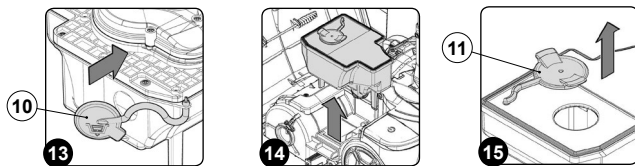

21. Replace the filling cap (11) in its seat on the detergent solution tank (Fig.16).
22. Remove the filter cartridge (12) and clean it under a jet of water to remove any impurities that might be attached. If necessary, replace it (Fig.17).
23. Insert the filter cartridge into its seat in the frame (12) (Fig.18).

ATTENTION: Put the filter cartridge in its seat as shown in figure 19, the valve activation pin (13) should be facing up.

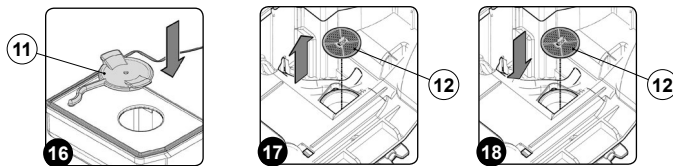

24. Insert the two tanks in the machine, positioning first the solution tank and then the recovery tank.
25. Remove the vacuum duct cleaning brush (14) from its support (Fig.20).
26. Clean the inside of the vacuum duct (15) with the brush (14) (Fig.21).
27. Put the vacuum duct cleaning brush (14) in its support (Fig.22).
28. Rotate the front carter (4) as far as the work position; do this with the aid of the handle (5) (Fig.23).
29. Block the handlebar in the horizontal position (Fig.24).

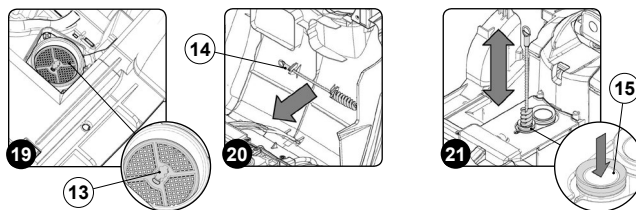

ATTENTION: During this operation, do not rest your foot on the machine.

30. Turn the stop lever of the command handlebar (16) in the direction of the arrow (Fig.22).
31. Close the vacuum tank again, pushing the handle (17) towards the body of the machine (Fig.23).
32. Turn the stop lever of the command handlebar (16) in the direction of the arrow (Fig.24).

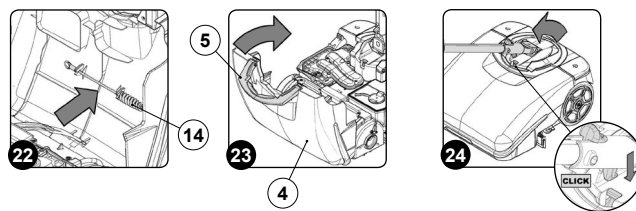

33. Position the machine with its rear in contact with the floor (Fig.25).
34. Make sure the squeegee body is in the work position. If it isn't, turn the knob (18) in the direction of the arrow (Fig.26).

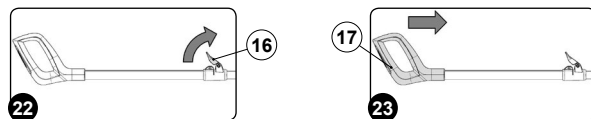

ATTENTION: Fig.26 shows the left side of the machine. Rotate the knob also on the right-hand side.

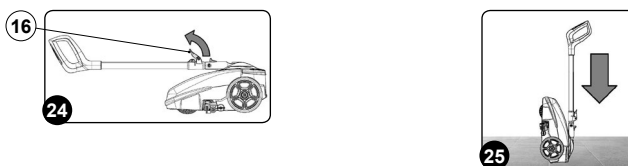

35. Move the squeegee coupling to the maintenance position, and move the knob (18) outwards (Fig.27). Rotate the squeegee coupling towards you (Fig.28).

ATTENTION: carry out this operation for both the left-hand knob and the right-hand knob.

36. Use a damp cloth to thoroughly clean the vacuum nozzle duct (19) (Fig.29).

ATTENTION: Be careful not to lose or damage the seal (20) above the vacuum nozzle (Fig.29).

37. Use a damp cloth to thoroughly clean the vacuum chamber of the squeegee (21) (Fig.30).

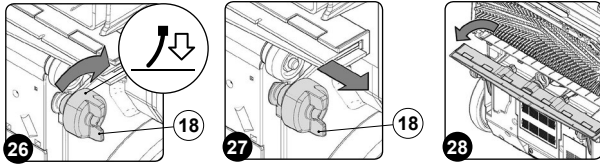

38. Use a damp cloth to thoroughly clean the front rubber (22) of the squeegee (Fig.31). Check the condition of the front rubber blade of the squeegee body; if the edge that is in contact with the floor is worn, replace it.

39. Use a damp cloth to thoroughly clean the rear rubber (23) of the squeegee (Fig.32). Check the condition of the rear rubber blade of the squeegee body; if the edge that is in contact with the floor is worn, replace it.

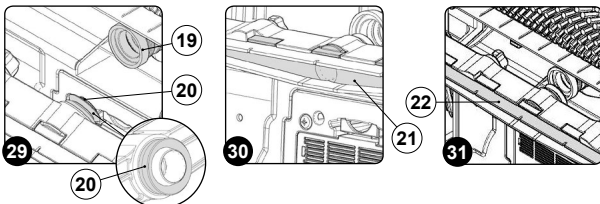

Careful maintenance of the squeegee rubbers guarantees better cleaning and drying of the floor, as well as a longer suction motor life. To replace the squeegee rubber blades, proceed as follows:

- Turn the wing nuts (24) fixing the squeegee body by 90° (Fig.33).
- Remove the squeegee body from the slots on the squeegee connector, taking care not to lose the seal on the vacuum nozzle (Fig.34).
- Replace the worn/damaged rubber.
- Repeat the operations in reverse order to reassemble all the parts.

40. Bring the squeegee coupling to the rest position and move the squeegee body towards the machine (Fig.35).

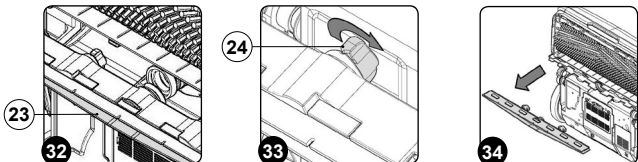

41. Fix the squeegee connection in the rest position, push the knob (18) towards the inside of the machine (Fig.36) and then turn it in the direction of the arrow (Fig.37).

ATTENTION: Fig.37 shows the left side of the device. Rotate the knob on the right side in the opposite direction.

42. Remove the exhaust air filter support (25) from the machine, press the fastening tab (26) in the direction of the arrow (Fig.38).

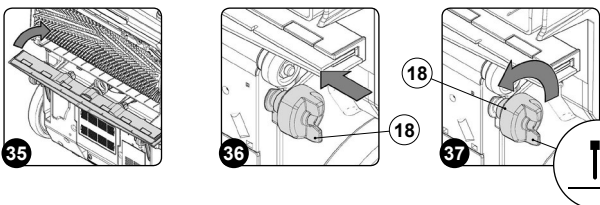

43. Clean the filter cartridges (27) with a jet of air (Fig.39), from a distance of at least 20 cm.

Careful maintenance of the exhaust air filters guarantees a longer suction motor life. To replace the filter cartridges, proceed as follows:

- Remove the filter cartridge supports (28) from the filter support (Fig.40).
- Remove the used filter cartridge (29) from the filter cartridge support (28) and replace it with the new one (Fig.41).
- Repeat the operations in reverse order to reassemble all the parts.

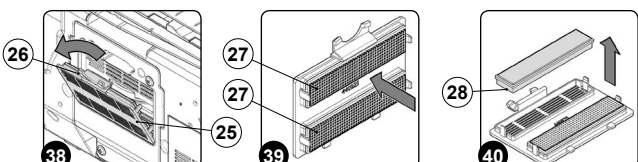

44. Insert the exhaust air filter support (25) in the machine (Fig.42).

45. Rotate the machine to its work position (Fig.43).

46. Block the handlebar in the vertical position; to release the handlebar move the latch (30) in the direction of the arrow (Fig.44).

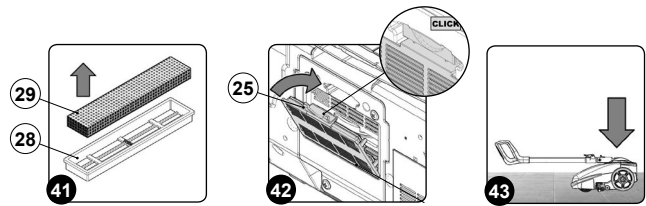

47. Rotate the front carter (4) as far as it will go - do this with the aid of the handle (5) (Fig.45).

48. Insert the two tanks and the detergent solution filter cartridge in the machine, positioning first the detergent solution filter cartridge, then the solution tank, and finally the recovery tank.

49. Rotate the front carter (4) as far as the work position - do this with the aid of the handle (5) (Fig.46).

50. Insert the battery in the battery compartment in the rear of the machine (Fig.47).

51. Position the machine with its rear in contact with the floor (Fig.48).

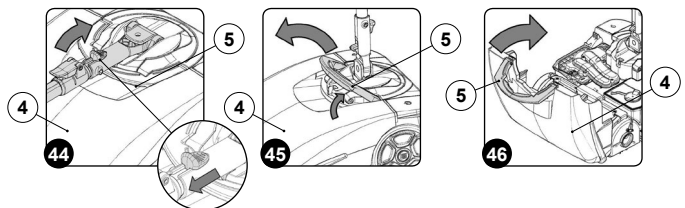

ATTENTION: Park the machine in an enclosed place, on a flat surface; near the machine there must be no objects that could either damage it, or be damaged through contact with it.

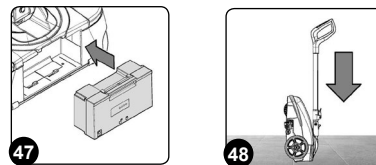

TROUBLESHOOTING

This chapter lists the most common problems linked with the use of the machine. If you are unable to resolve the problems with the information given here, please contact your nearest assistance centre.

PROBLEM	POSSIBLE CAUSE	SOLUTION
THE MACHINE DOES NOT START	The main switch is OFF.	Press the main switch.
	Check that the battery is correctly inserted in the machine.	Insert the battery correctly in the machine.
	Check the battery charge level, view the LED on the rear of the machine.	If the battery charge level is critical, perform a complete recharge cycle.
THE BATTERY HAS NOT BEEN CHARGED CORRECTLY	The power supply cable plug is not correctly inserted in the battery charger base socket.	Check that the plug on the battery charger power cable is connected to the socket on the battery charger base.
	The power supply cable plug is not correctly inserted in the mains socket.	Check that the battery charger power supply cable plug is connected to the mains socket.
	The characteristics of the mains power supply do not correspond to those required by the battery charger.	Check that the characteristics in the battery charger plate are the same as those of the mains supply.
THE MACHINE HAS A VERY LOW WORK AUTONOMY	The LED on the battery charger base flashes repeatedly.	Referring to the battery charger use and maintenance manual, check the meaning of the flashing signals that the battery charger emits during the battery recharge stage.
	Check the battery charge level and check the symbol on the control display.	If the battery charge level is critical, perform a complete recharge cycle.

PROBLEM	POSSIBLE CAUSE	SOLUTION
NOT ENOUGH DETERGENT SOLUTION ON THE BRUSH	The quantity of detergent solution in the water system is not sufficient for the work to be carried out.	Fill the solution tank with detergent.
	Detergent solution filter obstructed.	Remove the obstructions from the detergent solution filter (read " MAINTENANCE ").
THE MACHINE DOES NOT CLEAN CORRECTLY	The machine does not start.	Read the section " THE MACHINE DOES NOT START ".
	Not enough detergent solution comes out.	Read the section " NOT ENOUGH DETERGENT SOLUTION ON THE BRUSH ".
	The brush is not correctly inserted in the machine.	Insert the brush correctly in the machine.
	The brush bristles are subject to excessive wear	Check the condition of the brush, and replace it if necessary (read " MAINTENANCE ").
THE SQUEEGEE DOES NOT DRY PERFECTLY	The vacuum device is obstructed	Remove the obstructions from the squeegee body (read " MAINTENANCE ").
		Remove the obstructions from the vacuum duct (read " MAINTENANCE ").
		Remove the obstructions from the recovery tank cover (read " MAINTENANCE ").
EXCESSIVE FOAM PRODUCTION	The detergent being used is not suitable.	Check that a low foam detergent has been used.
	The floor is not very dirty.	Dilute even more the detergent inside the solution tank.
THE DEVICE DOES NOT VACUUM CORRECTLY	The recovery tank is full	Empty the recovery tank (read the chapter " AT THE END OF THE WORK ").
	The vacuum device is obstructed	Read the section " THE SQUEEGEE DOES NOT DRY PERFECTLY ".

EC DECLARATION OF CONFORMITY

The undersigned manufacturer:
FIMAP S.p.A.
 Via Invalidi del Lavoro, 1
 37059 Santa Maria di Zevio (VR)
 declares under its sole responsibility that the products
SCRUBBING MACHINE mod. FIMOP

comply with the requirements of the following Directives:

- 2006/42/EC: Machinery Directive.
- 2014/35/EU: Low Voltage Directive.
- 2014/30/EU: Electromagnetic compatibility directive.

They also comply with the following standards:

- EN 60335-1:2012/A11:2014
- EN 60335-2-72:2012
- EN 60335-2-29:2004/A2:2010
- EN 61000-3-2:2014
- EN 61000-3-3:2013
- EN 55014-1:2006/A1:2009/A2:2011
- EN 55014-2:2015
- EN 62233:2008/AC:2008

The person authorized to compile the technical file:

Mr. Giancarlo Ruffo
 Via Invalidi del Lavoro, 1
 37059 Santa Maria di Zevio (VR) - ITALY

Santa Maria di Zevio, 29/10/2019

FIMAP S.p.A.
 Legal representative
 Giancarlo Ruffo



DISPOSAL



To dispose of the machine, take it to a demolition centre or an authorised collection centre. Before scrapping the machine, the materials must be removed and separated in accordance with the current legislation on environmental health.



FIMAP S.p.A. - Via Invalidi del Lavoro, 1 - 37059 S. Maria di Zevio - Verona - Italy
Tel. +39 045 6060411 – Fax +39 045 6060417 – E-mail:fimap@fimap.com
www.fimap.com